



Aquanomic EU™ Solid Laundry Dispenser



Operation & Programming Manual

Retain this manual for Operation & Programming information.

370 Wabasha Street N. St. Paul, MN 55102

www.ecolab.com

© 2016 Ecolab Inc. All rights reserved.

47714/0402/0316 Part No. 9259-2566

Contents

1.0	Operation	3
1.1	General Information.....	3
1.1.1	Definitions and Conventions	
1.1.2	Icon Descriptions	
1.1.2.1	Idle Screen Icons	
1.1.2.2	Error Icons	
1.1.2.3	Soft Key Icons	
1.1.2.4	Programming Icons	
1.1.3	Controller Components	
1.2	Customer Screens.....	8
1.3	System Alarms.....	16
2.0	Programming	17
2.1	Submenu #1.0 Account Menu.....	18
2.2	Submenu #2.0 Quick Setup:.....	21
2.3	Submenu #3.0 System Menu:.....	25
2.4	Submenu #4.0 Formula Menu.....	35
2.5	Submenu #5.0 Prime Pump- for optional liquids.....	41
2.6	Submenu #6.0 Calibration- for optional liquids.....	43
2.7	Submenu #7.0 View System Info.....	42
2.8	Submenu #8.0 Diagnostics.....	52
3.0	Start-Up and Operation	57
3.1	Product Wash/Signal Check.....	57
3.2	Hydraulics Check.....	57
3.3	Product Dispense Check.....	57
3.4	Customer Operation.....	58
4.0	Troubleshooting	59
5.0	Wiring Diagrams	62
5.1	MSI Wiring Diagram.....	62
5.2	IO Board Wiring.....	63
5.3	Pump Cabinet wiring.....	64
6.0	Maintaining and Servicing the System	65
6.1	Pump and Outlet Manifold Replacement Procedure.....	65
6.2	Electrical components behind I/O Board enclosure.....	65
7.0	Operating Instructions for Account Personnel	66
7.1	Introduction to AQUANOMIC EU.....	66
7.2	Selecting a Wash Formula.....	67
7.3	System Alarms.....	72
7.4	Viewing Load Counts.....	74
7.5	Replacing Empty Products.....	75
8.0	Replacement Parts	76

1. Operation

1.1 General Information

This manual has been written and illustrated to present the basic operations and programming instructions of the Aquanomic EU dispenser. This manual applies to current units. Future versions may have additional features; check unit packing for the latest revision.

Guidelines will be suggested in reference to the preferred method of installation. However, the variety of equipment and the surrounding environment will dictate the actual operation of the Aquanomic EU unit.

⚠ WARNING

These installation, operation and servicing instructions are for use by qualified personnel only. The SCLS system is intended to be installed by an experienced, qualified technician. The installation must be made in accordance with all applicable and local plumbing and electrical codes. The dispenser must be properly plumbed to a laundry washer / extractor. The washer extractor must have a properly installed drain system or overflow protection system.

The remarks WARNING, CAUTION and NOTICE have the following meanings in this manual.

⚠ WARNING

This heading refers to a hazard or unsafe practice which can result in severe personal injury or death.

⚠ CAUTION

This heading refers to a hazard or unsafe practice which can result in personal injury or product or property damage.

NOTICE

This heading is used when a particular piece of information needs to be highlighted.

The information provided here will take you step-by-step through the programming of the Condor Laundry Controller.

1.1.1 Definitions and Conventions

- **Idle Screen or Customer's Screen** –Screens that display laundry icons and soft keys when the Controller is in idle mode.
- **Menu** – A selection of action choices presented on the graphical LCD display.
- **Scroll** – To move through menu selections by pressing the Up arrow or Down arrow keys.
- **Select** – To press the center <Enter> key on the keypad. This action advances the user to the next sub-menu.
- **Programming** – The action of setting up the values, operating methods, and messages that are available for change.
- **Default** – Factory programmed values.
- **Parameters** – Values and limits set during programming.
- **Standard Mode (Normal Operation)** – The dispenser will dose as it receives chemical supply signals from the washer. The user needs to select a formula on either the Condor controller, or on the optional Formula Select module.
- **MicroMode (Automatic Formula Selection Mode)** – The dispenser will automatically select a formula based on the time duration of the washer supply signal. To use this mode of operation, the MicroMode signal from the washer is wired into the MSI signal #1 (with black wire). Once triggered, the dispenser will

automatically select a formula and start dosing the product(s) that were programmed for MSI Signal #1 (or Step #1).

- **Program Mode** – Mode in which password-protected menus are available. These menus allow the setup of wash formulae and reviewing/editing of all operating parameters on the controller.
- **Auto Key Repeat** – A feature that allows you to press and hold keys instead of repeating key strokes.

1.1.2 Icon Descriptions

The controller is capable of displaying some graphics information, as well as text information. The display will include icons to minimize language concerns. Icons are populated at the bottom of the controller display to indicate which soft keys (SK) are active.

1.1.2.1 Idle Screen Icons



Home screen is the only screen that allows you to get access to the password screen. It also allows you to select each washer for additional information/status.



Laundry load counts



Status

Status or more information is offered



FO0

Washer and formula selection (Washer #1 - no formula selected)



FO1

Washer and formula selection (Washer #1 - Formula #1 selected)

Select Formula



Select a formula from main idle screen. Note the use of the arrow.

Modify Formula



Modify a formula: Cancel or activate/deactivate Note the use of the pencil.



System Queue

1.1.2.2 Error Icons



Formula Not Finished Alarm

Machine Signal Box Comm. Error







Machine Signal Interface (MSI) communication error (with a red display)











Formula Selection Box Comm. Error





Formula Select communication error (with a red display)



















	Main IO circuit board communication error
	Main power reset (to entire system)
	Empty product container
	Disable (an audio alarm or a step)

1.1.2.3 Soft Key Icons

<small>Home</small> 	Home - SK#1 Go to the main idle screen (or Ready screen) to select a washer or go to the password protected screen for programming the system
	Laundry load counts
<small>Status</small> 	Status or more information is offered
<small>Select Formula</small> 	Select a formula from main idle screen. Note the use of the arrow.
<small>Modify Formula</small> 	Modify a formula: Cancel or activate/deactivate. Note the use of the pencil.
<small>Signal Module</small> 	Status of Machine Signal Interface (MSI) module
<small>Time Frame</small> 	Time Period: to allow for specifying reporting time period parameters (washer load counts, error logs, etc.)
	Delete/Clear log
	Prime function - SK #4 Set up in programming mode to allow for customer (or user) to prime product pumps to washer when an empty container is replaced.
	System Queue
	More Information

1.1.2.4 Programming Icons

	Use Left or Right Arrow keys to adjust a programming item
	Use Up or Down Arrow keys to scroll through sub-menus displayed in screen
	Save to memory

	Back to previous screen (usually assigned to SK #1)
	Exit out of programming mode, back to main idle screen (customer's screen)
	Edit mode (note the use of a pencil)
	Copy mode
	Test a component (Formula Select or MSI or IO module for their revision of installed software)
	Edit a step (note the use of a pencil)
<small>Summary</small> 	Summary: list the information (in a formula)
	More: more information is available
<small>Edit Product</small> 	Edit product. (note the use of a pencil)
<small>Reset</small> 	Reset this selection ONLY
<small>Reset All</small> 	Reset all (back to new factory settings)
<small>No</small> 	No (to confirm a selection)
<small>Yes</small> 	Yes (to confirm a selection)
<small>Disable</small> 	Disable (an audio alarm)
<small>Pump</small> 	Pump
<small>On</small> 	On: activate a component (pump or valve)
<small>Off</small> 	Off: de-activate a component (pump or valve)
<small>Pickup Probe In</small> 	Test the integrity of the pick-up probe and its wiring in a full container. The float switch inside the probe should be in the up position.
<small>Pickup Probe Out</small> 	Test the integrity of the pick-up probe and its wiring in an empty container (or outside of a container). The float switch inside the probe should be in the down position.

1.1.3 Controller Components

Upon power up, the Condor will perform an initialization sequence (1-2 minutes) before displaying the main idle screen.

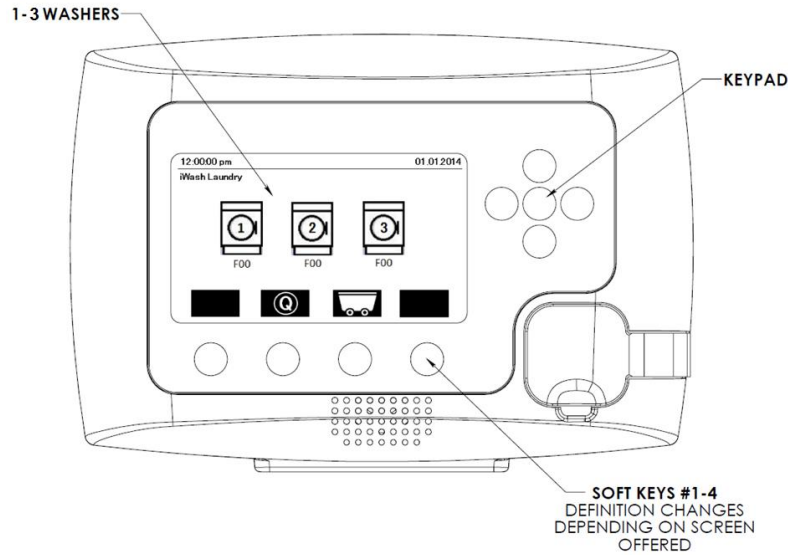

1. DISPLAY:

Idle screen: Washer status and access to load counts or formula selection.
 Program mode: Data entry request/menu/settings display.

2. KEY PAD:

These keys provide a means for selecting/reviewing/programming the controller:

Idle Screen Keypad Functions	
Key	Function
Center <Enter>	- Access to password protected settings - Access to individual washer status, or to manually select/cancel a formula based on soft key offerings
Up Arrow	No function
Down Arrow	No function
Left Arrow	- Move between washer icons (use <Enter> to access user options for wash formulae)
Right Arrow	- Move between washer icons (use <Enter> to access user options for wash formulae)

Programming Screen Keypad Functions	
Key	Function
Center <Enter>	Menu selection
Up Arrow	- Scroll options for sub-menus - Increment a parameter
Down Arrow	- Scroll options for sub-menus - Decrement a parameter
Left Arrow	Increment a parameter
Right Arrow	Decrement a parameter

Soft Keys #1 - #4 (at bottom of display):

These soft keys offer dynamic functions based on the sub-menus selected.

- Idle screen:
 - allow access to washer load counts
 - allow access to washer info (status)
 - allow access to user options for wash formulae
- Programming Mode:
 - various functions based on sub-menu selection

1.2 Customer Screens

This section describes the screens available to the customer and/or operator (non-programming mode). The screens depicted in the following sections are snap-shots of the optional Formula Select Module (FS) and Condor Controller. It should be noted that each FS module is set at a unique communication address and displays information specific to the washer assigned to it. In some cases it will also display total system information.

- **Normal Operation Idle Screens (non-MicroMode)**

Formula Select module



F00 No Program is displayed:

- Use the Up/Down key on the FS module to scroll through the formulae.
- Use the center <Enter> key to select a formula.
- Use BOTH Up + Down keys to cancel a formula.

Condor Controller

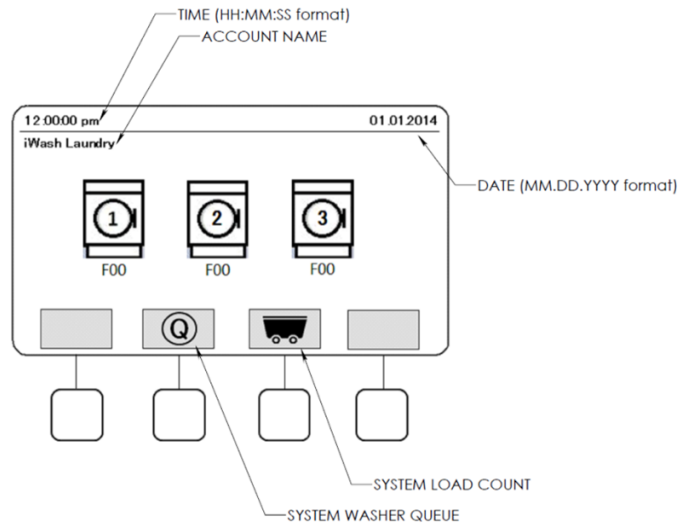

Idle screen for a 3-washer account:

Time, account name, and date are displayed, as well as the status of each of the 3 washers. In this case, all machines are idle (F00 no formula selected).

Choosing SK#2 System Queue will show all of the dispenser's chemical requests in the order that they will be dosed.

Choosing SK#3 Load Counts will list production load counts for all, or each, of the washers.

Use the Left/Right arrows on the keypad to highlight/select any of the washers. This will update the soft key options.

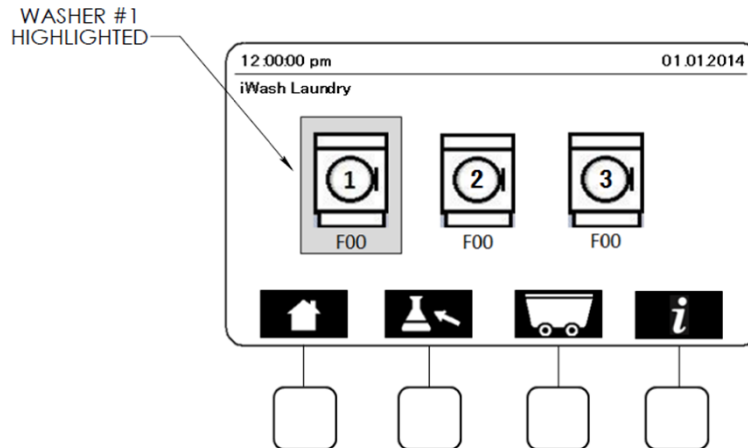

For example, Washer 1 is highlighted using the Left/Right arrow keys. Four soft keys are now made available.

Choosing...

SK #1: Home – navigates back to the main idle screen

SK #2: Select a Formula – prompts user to select a formula for Washer 1

SK #3: Load Counts – displays load counts for Washer 1

SK #4: Info – displays more information for Washer 1

When a machine is being actively serviced, the Condor will indicate this by displaying this icon above the active washer

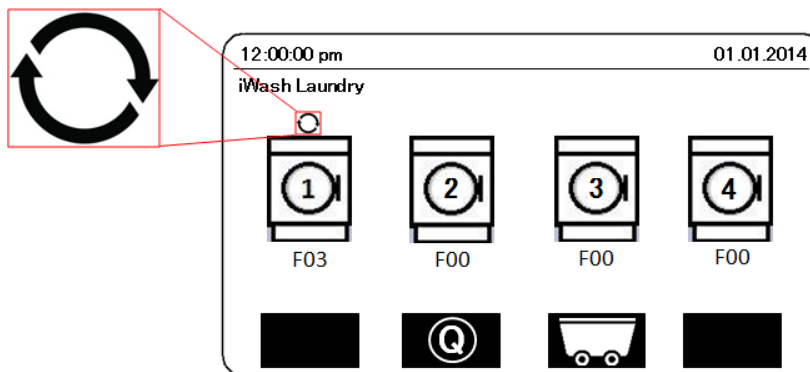



Select Formula (SK#2)

Selecting SK#2 opens a list of the pre-programmed formulae available.
 Use the Up/Down arrow to highlight a formula.
 Press center <Enter> to select the formula.

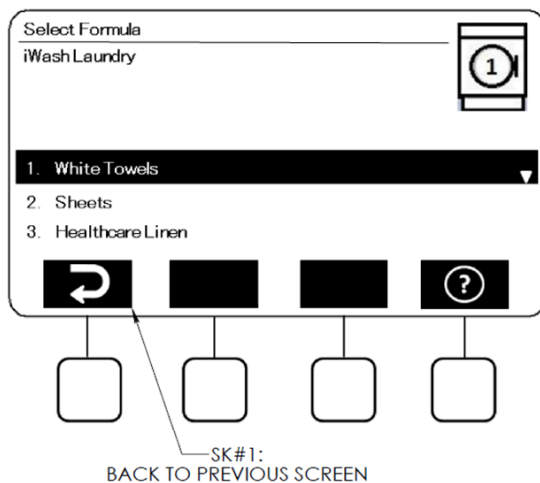

If Formula F03 Healthcare Linen is selected, the controller will momentarily display the screen below while the command is processed.

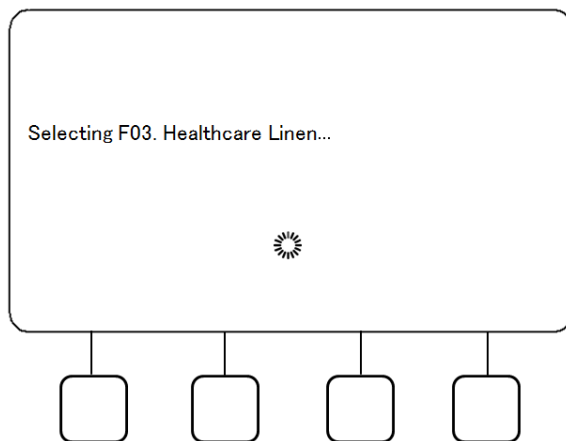

If the formula selection is successfully processed, the Formula Select module for Washer 1 (if installed) will update to show F03 Healthcare Linen.

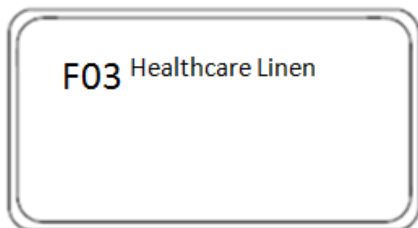

The Condor Controller will then display F03 underneath Washer 1 on the main idle screen.

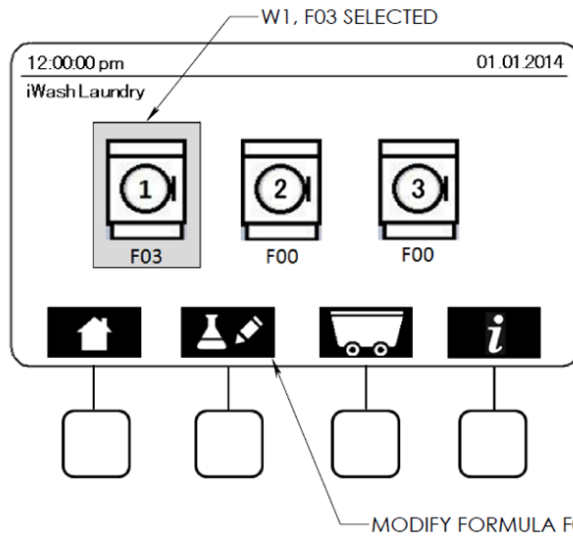

With Washer 1 still highlighted, the existing options for soft keys SK#1, #3 and #4 are again available. However, SK#2 has changed to “Modify Formula”. Note the use of a pencil pictogram (rather than an arrow for “Select Formula”).

Modify Formula



Selecting SK#2 will give you the option of cancelling the current formula:

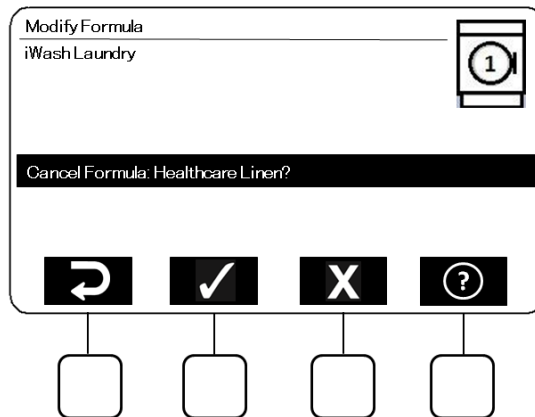

Press SK#2 <Yes> or SK#3 <No> to confirm your selection.
Press SK#1 <Back> to cancel.

If the formula is cancelled, the selected formula (F03) for this selected washer will be reset and all doses will be removed from the system queue. The main idle screen on the Condor and the Formula Select will display F00 No Program.

Select a Formula Screen: Formula Selection Error

If the formula selection cannot be successfully processed (caused by a communication failure or a delay in system communication due to system synchronization), an error message will appear:

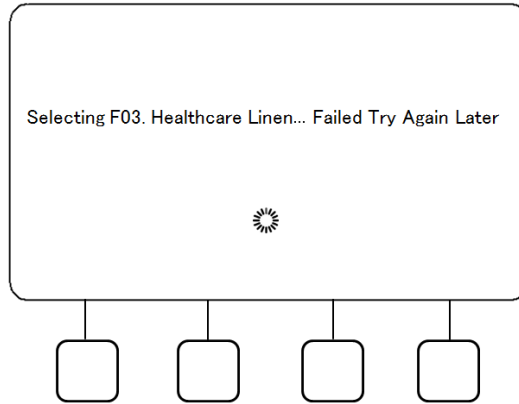

Select a Formula Screen: MicroMode

If the washing machine is utilizing MicroMode, the select formula screen will be offered. However, a formula cannot be selected using the manual keypad. The Center <Enter> key is now disabled.

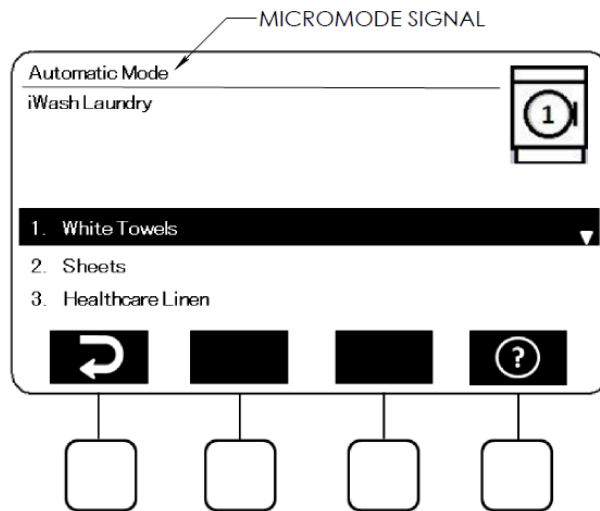

Additionally, if the washer is in MicroMode, the corresponding Formula Select screen will display "Automatic Mode" on the top line.

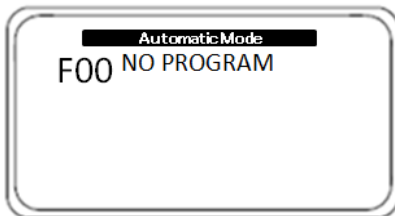



Load Counts (SK#3)





SK #3 will display the production load counts of each formula of the selected washer. The production volume of dry linen is displayed in the 'lb' column. These numbers are calculated based on the washer capacity and the number of cycle counts.

Use the Up/Down key to browse through all load counts for all formulae.
 Press SK#1 <Back> to return to the previous screen.

Load Counts			
iWash Laundry 			
#	Total	Cycles	lb
1.	White Towels	0	0
2.	Sheets	0	0
3.	Healthcare Linen	0	0
4.	Color Bed Linen	0	0









Status





More Information (SK#4)

If a formula is active for the selected washer (in this example, F03 Healthcare Linen) and SK#4 is selected, the following screens will be displayed.

If no step in the formula has been dosed yet:

Active Formula Status			
			
F03. Healthcare Linen			









If a wash step has been dosed:

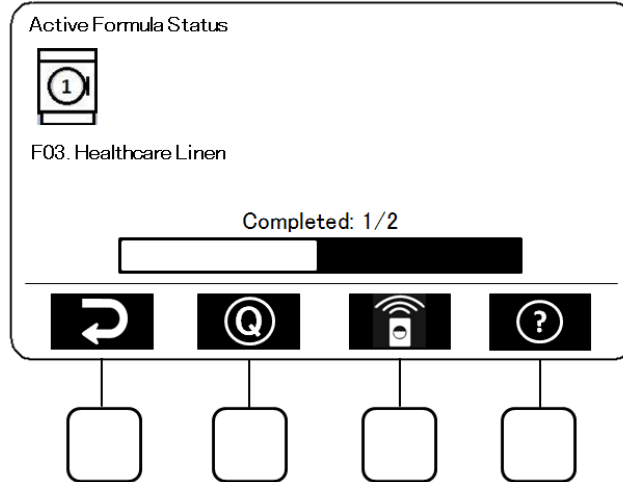

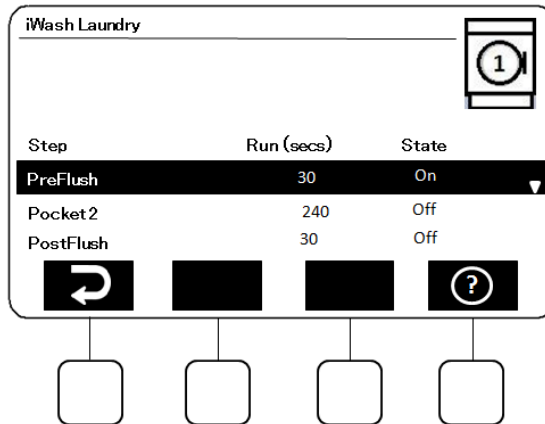

More Information (SK#4)  → Queue (SK#2) 

If SK#2 Queue is selected from the More Information screen, the status of every activity as the system services the selected washer's request will be displayed (if a washer signal is active). The amount of run time remaining for each step and the status (on/off) is shown.



More Information (SK#4)  → Signal Module (SK#3) 









Selecting SK#3 Signal Module will show the detailed status of the active washer signal that is being serviced.



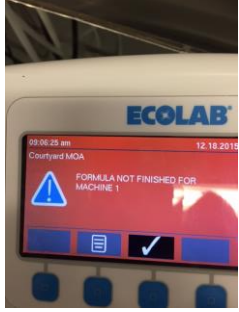



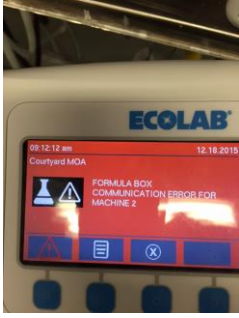

Signal Module > Washer 1 > Signal 1	
PocketNo #	1
Amount(Grams)	17.00
Dispensed Amount (Grams)	0.00
Temperature (°F)	120.00
Conductivity (uS)	300.00
	
	

Line #1: Active Pocket No. (Pocket #1)
 Line #2: Amount to Dispense (Grams) (17.00)
 Line #3: Dispensed Amount (Grams) (0.00)
 Line #4: Temperature (°F) (120.00)
 Line #5: Conductivity (uS) (300.00)

1.3 System Alarms

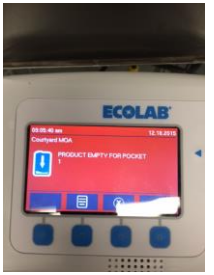
Alarms screens are typically displayed on the Condor with a red background. The images below are displayed on the Formula Select and Condor controller when the system detects an operating parameter outside of its designed specifications.

Error Displayed	Error Definition	To Clear Error on...		
		Formula Select	Condor Controller	
	<p>Formula Not Finished (incomplete formula)</p> <p>Occurs when the Condor does not receive all signals programmed into a wash formula or a product is not fully delivered (out of product, etc.)</p> <p>Causes:</p> <ul style="list-style-type: none"> - Washer has been forwarded (chemical request signals skipped) - Chemical request signals not properly programmed on washer - Operator opens washer door and leaves for day/shift/break (washer times out) - Solid or liquid product is empty (or nearly empty) - System is plugged downstream of sump screen - Wash step has been deleted from queue 	Press Any Key		
	<p>MSI Communication Error</p> <p>Occurs when communication is lost to an MSI module.</p> <p>Causes:</p> <ul style="list-style-type: none"> - Poor/broken communication cable connection - Faulty MSI Module - MSI Module(s) are improperly addressed <p>Effect: Service is lost to any washer in the daisy chain after the point of failure. System operation will be adversely affected.</p> <p>Contact Ecolab Service Personnel</p>	Press Any Key		
	<p>Formula Select Communication Error</p> <p>Occurs when communication is lost to a Formula Select module.</p> <p>Causes:</p> <ul style="list-style-type: none"> - Poor/broken communication cable connection - Faulty Formula Select Module - Formula Select Module(s) are improperly addressed - Optional Formula Select configuration not properly set up in System Settings <p>Effect: Service is lost to any washer in the daisy chain after the point of failure. System operation will be adversely affected.</p> <p>Contact Ecolab Service Personnel</p>	Press Any Key		

	<p align="center">IO Board Communication Error</p> <p>Occurs when communication is lost to the IO board.</p> <p>Causes:</p> <ul style="list-style-type: none"> - Poor/broken communication cable connection - Faulty IO board <p>Effect: System will not operate.</p> <p align="center">Contact Ecolab Service Personnel</p>	<p align="center">NA</p>	<p align="center">Alarm can't be cleared. Service required.</p>	
	<p align="center">Product Empty for Pocket X (solid product)</p> <p>Occurs when conductivity reading does not reach expected level.</p> <p>Causes:</p> <ul style="list-style-type: none"> - Empty product container - System plug at or downstream of sump screen <p>Effects:</p> <ul style="list-style-type: none"> - Product X will not dose - Formula Not Finished alarm will occur at end of wash formula 	<p align="center">Press Any Key</p>		
	<p align="center">Product Empty for Pump X (liquid product)</p> <p>Occurs when liquid product level sensor triggers out of product.</p> <p>Causes:</p> <ul style="list-style-type: none"> - Liquid product container is empty. - Liquid product level sensor is faulty or disconnected. <p>Effects:</p> <ul style="list-style-type: none"> - Liquid product pump for triggered product will not pump. - Formula Not Finished alarm will occur at end of wash formula 	<p align="center">Press Any Key</p>		

2. Programming

To enter the programming mode, press and hold the Center <Enter> key for 4+ seconds from the main screen. The controller should prompt the user for a password.

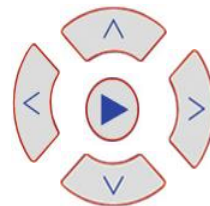
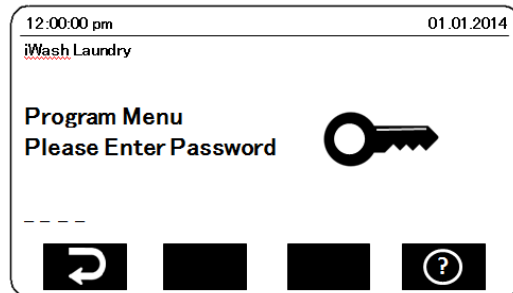

Enter the controller password by pressing <Up>/<Down>/<Left>/<Right>.

Once the password has been entered correctly, the Program Menu will appear.

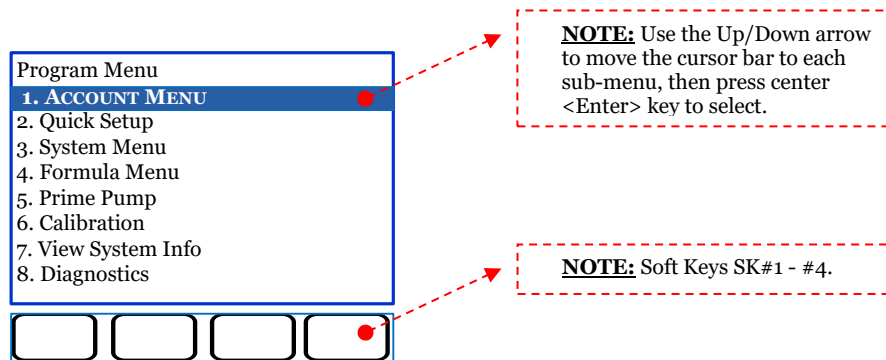

Notes:

- Program Mode menus and settings can also be accessed by Ecolab applications for mobile devices.
- Press and hold arrow keys to use the “auto key repeat” feature for faster scrolling.
- **If there are no keys pressed for 5 minutes, the system will exit the password-protected programming mode and display the main idle screen. The password must be re-entered to access the Program Mode menus again.**

2.1 Submenu #1.0 Account Menu

Most account menus and sub-menus are available for viewing-only on the Condor. Their setup will need to be done on Ecolab tablets or mobile devices and downloaded via the Ethernet port on the front of the controller.

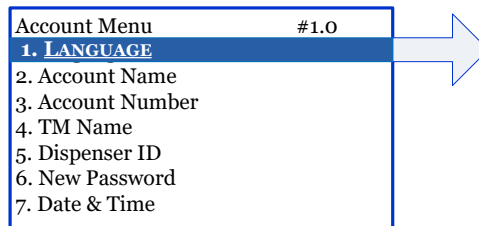

2.1.1 Submenu #1.1 Account Menu>Language:

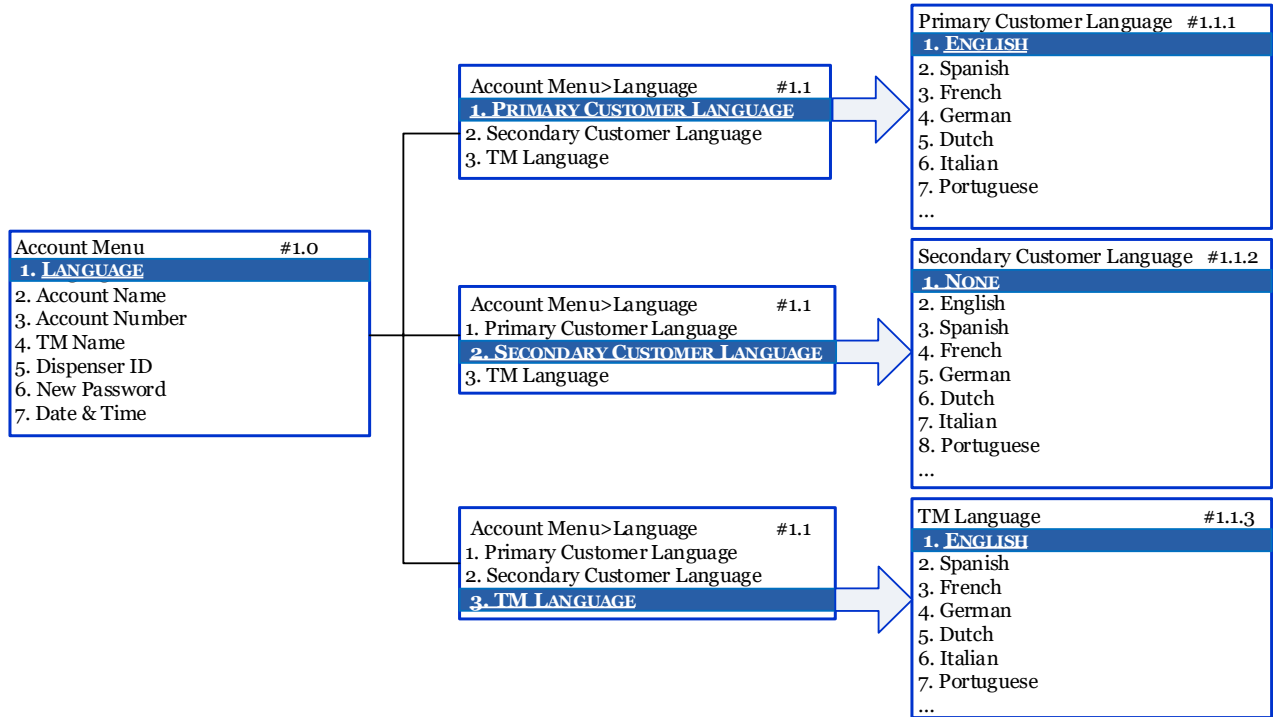

Screen	Description
1.0	Account Menu This submenu is used to set various account parameters including language, account name, TM name and other important information. Many of these parameters can only be set using an Ecolab tablet or mobile device.
	<ENTER> Proceed to setup Language
1.1	Language The Controller can be set up with three different languages – Primary Customer Language, Secondary Customer Language, and TM Language. Primary Customer Language – Select a language to display system information to the customer in the main idle screens. Secondary Customer Language – Select a language to display system information to the customer in the main idle screens. TM Language – Select a language to display the system program information to the TM servicing the account.
	<ENTER> Proceed to select language for highlighted selection
1.1.1 1.1.2 1.1.3	Select Language Select a language from the options available.
	 Save language

2.1.2 Submenu #1.2 Account Menu>Account Name:

In this menu, the account name can be viewed. The Account Name can only be set up using an Ecolab tablet or mobile device.

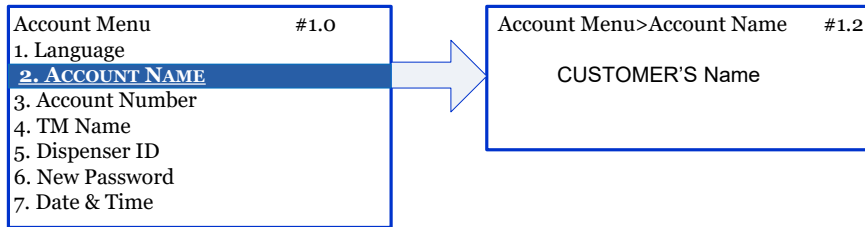

2.1.3 Submenu #1.3 Account Menu>Account Number:

In this menu, the account number can be viewed. The Account Number (8-digit) can only be set up using an Ecolab tablet or mobile device.

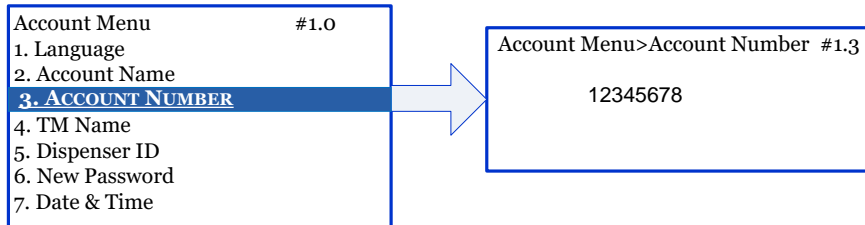

2.1.4 Submenu #1.4 Account Menu>TM Name:

In this menu, the TM name and phone number can be viewed. The TM name and phone number can only be set up using an Ecolab tablet or mobile device.

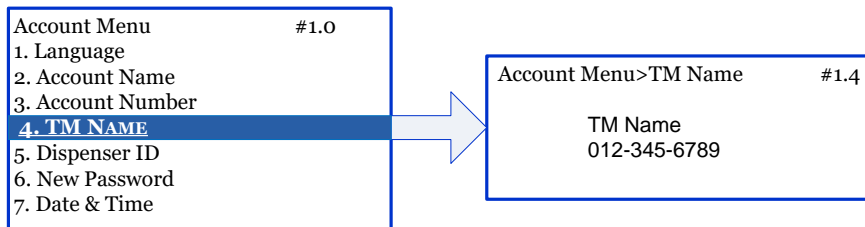

2.1.5 Submenu #1.5 Account Menu>Dispenser ID:

In this menu, the Dispenser ID can be viewed. The Dispenser ID can only be set up using an Ecolab tablet or mobile device.

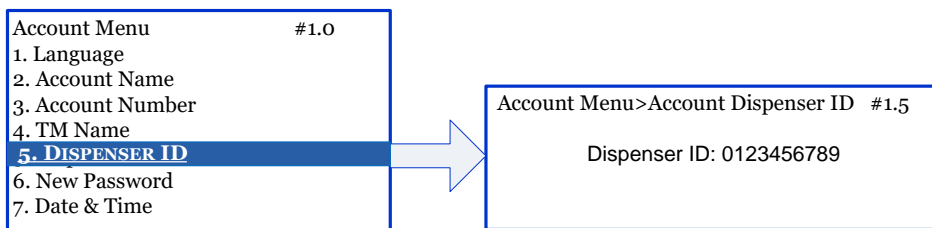

2.1.6 Submenu #1.6 Account Menu>New Password:

In this menu, the programming password can be changed (4-digit password).
Press SK#3 <Save> to save selection.
Press <Back> to cancel selection and return to previous screen.

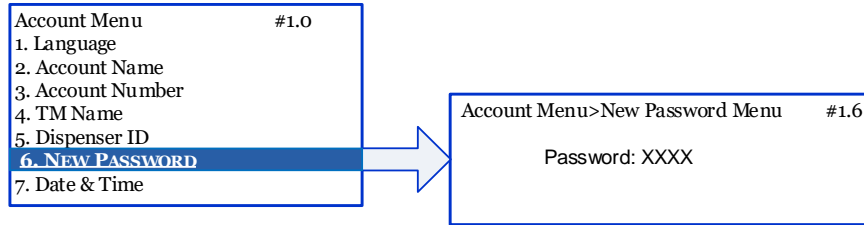

2.1.7 Submenu #1.7 Account Menu> Date & Time:

In this menu, the installation date and time can be viewed. The system date and time can be entered in Quick Setup>4.Date & Time or by using an Ecolab tablet or mobile device.

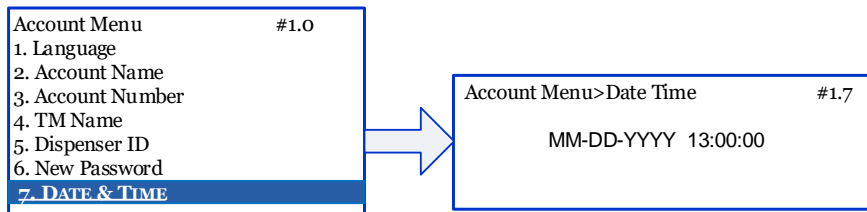

2.2 Submenu #2.0 Quick Setup:

The Quick Setup menu parameters can be set using an Ecolab tablet or mobile device, or by using the arrow keys on the front of the controller.

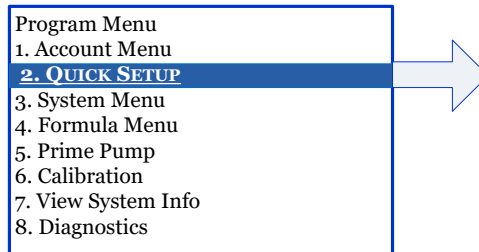

2.2.1 Submenu #2.1 Quick Setup>Select Location:

Select the location of the account.

- North America
- Europe
- APLA

Press SK#3 <Save> to save selection. Press <Back> to cancel selection and return to previous screen.

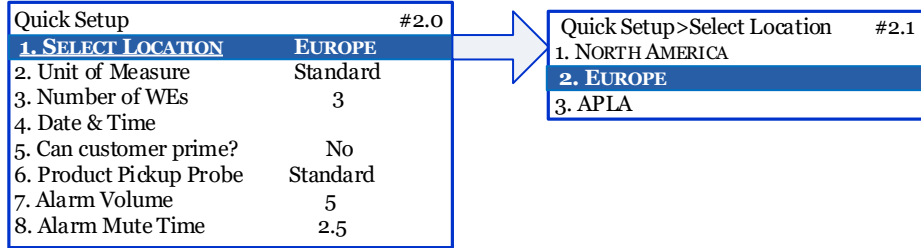

2.2.2 Submenu #2.2 Quick Setup>Unit of Measure:

Select the desired UOM with the suggested Date & Time format.

- Standard UOM: - weight will be edited, saved, and displayed in OZ and LB
- Date is displayed in Month-Day-Year (MM DD YYYY) format

- Metric: - weight will be edited, saved, and displayed in mL and Kg
- Date is displayed in Day-Month-Year (DD MM YYYY) format

Press SK#3 <Save> to save selection. Press <Back> to cancel selection and return to previous screen.

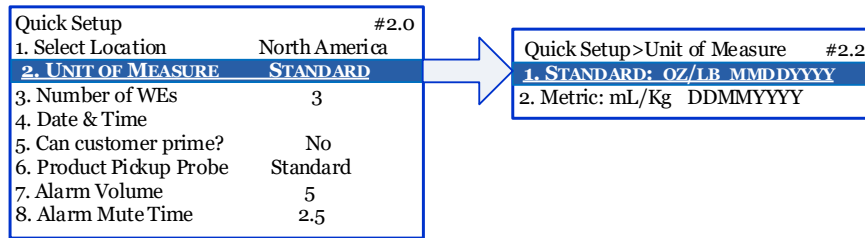

2.2.3 Submenu #2.3 Quick Setup>Number of WEs:

Set the number of washers (maximum = 3) installed at this account.

Use the Left/Right arrow keys to select the desired number (1 - 3).

Press SK#3 <Save> to save selection. Press <Back> to cancel selection and return to previous screen.

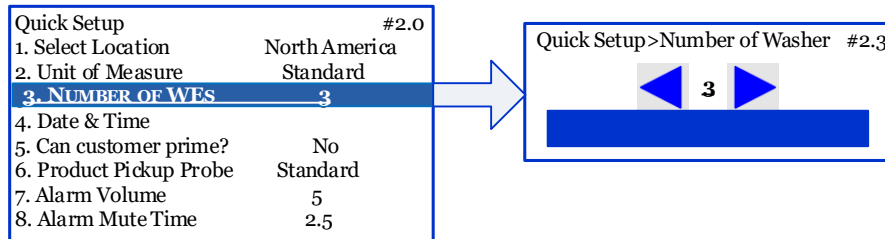

2.2.4 Submenu #2.4 Quick Setup>Date & Time:

Set up installation Date and Time in the UOM format previously selected.

Use Left/Right keys to move between fields.

Use Up/Down keys at each field location to set the numeric values and to toggle between am/pm in Time setup.

Press SK#3 <Save> to save selection. Press <Back> to cancel selection and return to previous screen.

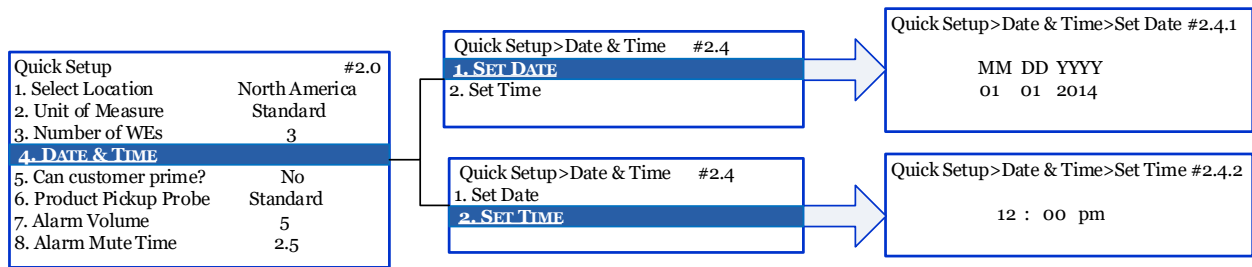

2.2.5 Submenu #2.5 Quick Setup>Can customer Prime?

The Customer Prime function allows the user to prime a pump after replacing an empty product container. If the prime command is selected when the system is in the middle of a dose, the prime will be delayed until the current dose is complete.

⚠ WARNING

If this option is enabled, it is extremely important the customer is trained on proper priming procedures.

If the Customer Prime option is enabled, the main idle screen will display soft key (SK#4) with icon . The controller will guide the user through the process.

Press SK#3 <Save> to save selection.

Press <Back> to cancel selection and return to previous screen.

NOTICE

Prime will automatically begin, but not until the system is finished with the current dose.

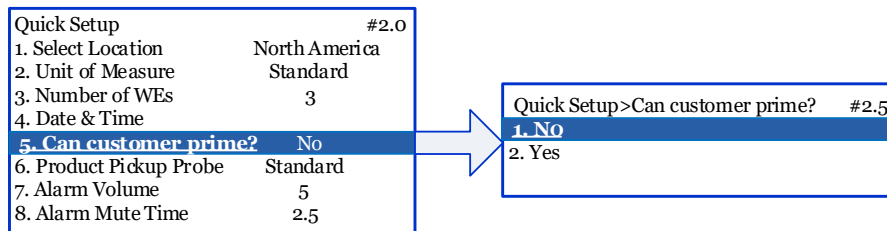

2.2.6 Submenu #2.6 Quick Setup>Product Pickup Probe

Select the type of Out-of-Product sensor (if installed) that is used on the product pickup probes. This will alert the customer when the liquid product container is empty. If Out-of-Product sensors are not used, this menu selection will have no effect on system operation.



Standard – Uses a float switch to sense the level of product in the container. When the product drops below pre-set level, the float switch closes and an audible alarm is activated to warn the user of low product. An empty alarm delay (in seconds) is offered to allow advanced warning of low product. Standard pick up probes have a float switch designed to sense the level of product in the container.

Use Left/Right arrow keys to set the desired time (3 – 30 seconds). Default is 3 seconds.
 Press SK#3 <Save> to save selection.
 Press <Back> to cancel selection and return to previous screen.

- NOTICE**
- 1) The system is shipped with this feature disabled for all 3 liquid products. There is a row of 3 connectors and OPEN plugs (S1-S3) located at the bottom of the IO board. This simulates an always-full product. If the jumper is connected ('S' and '-' pins are closed), an empty product alarm will be displayed and logged.
 - 2) The '+' pins are reserved for the capacitive sensor (future use). Do not connect the '+' pins to standard sensor.

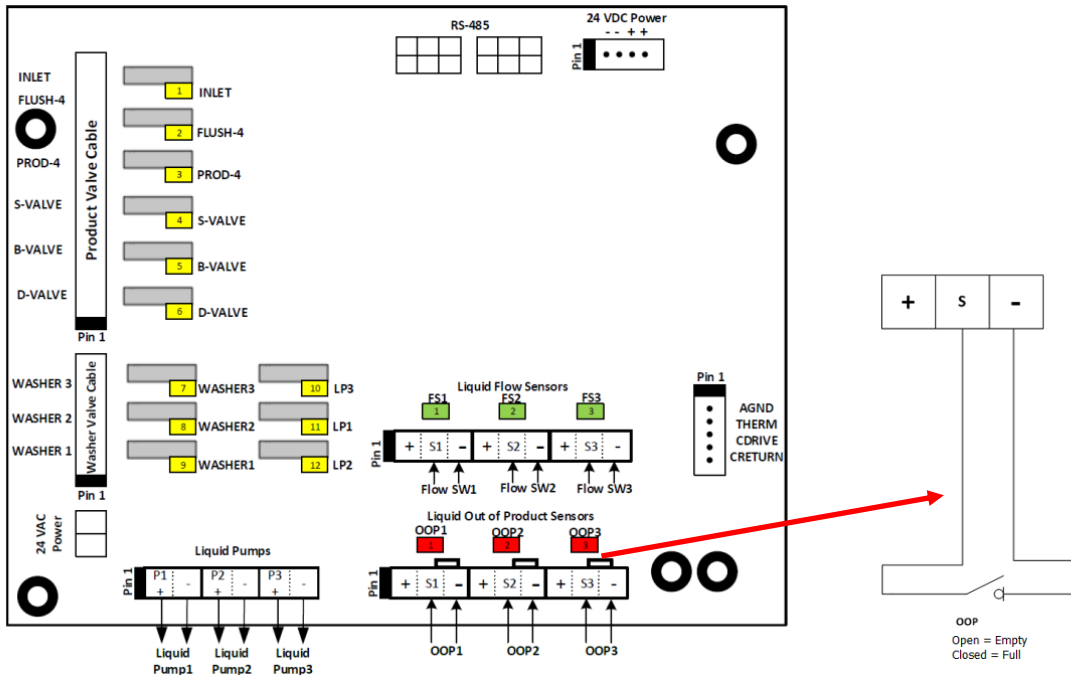

- NOTICE**
- If the installation uses only 1 float sensor (1 liquid product pail) with 3 washing machines, the wiring needs to use jumpers so any washer can determine an Out Of Product Alarm.

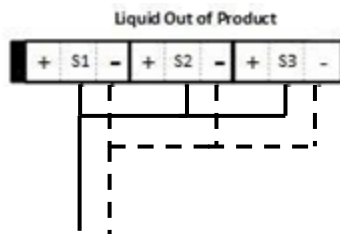

2.2.7 Submenu #2.7 Quick Setup>Alarm Volume

Adjust the alarm volume using this screen.

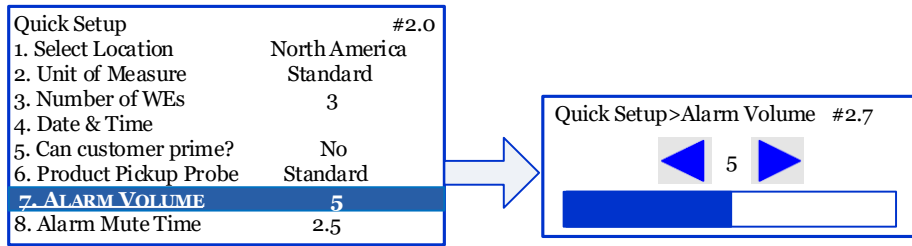

2.2.8 Submenu #2.8 Quick Setup>Alarm Mute Time

Adjust the alarm mute time using this screen.

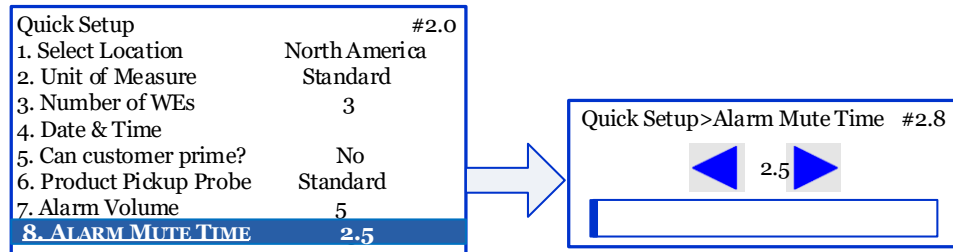

2.3 Submenu #3.0 System Menu:

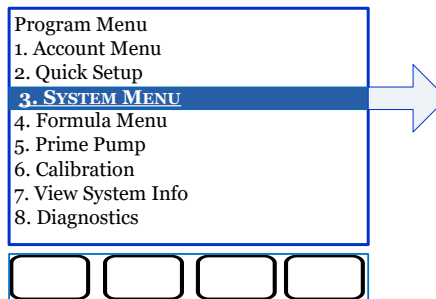

2.3.1 Submenu #3.1 System Menu>Washer Settings:

- To Copy washer settings from a washer to another, select the washer you want to copy from, and press SK#3 <Copy>. Then Select the washer you want to copy into and press SK#3 <Yes> to confirm a selection

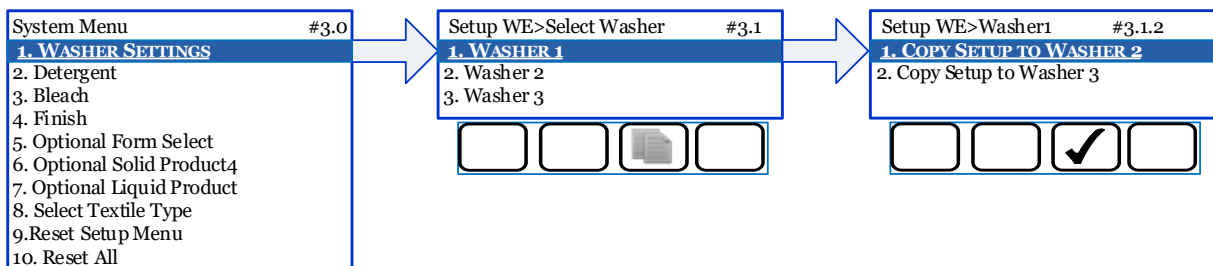

- To edit washer settings, Select a washer to set up Name, Capacity, Chart Stop feature (Yes/No), Additional Flush, Signal Validation Time, and Signal Mode (Standard/MicroMode). Press SK#2 <Edit> to setup the desired washer.

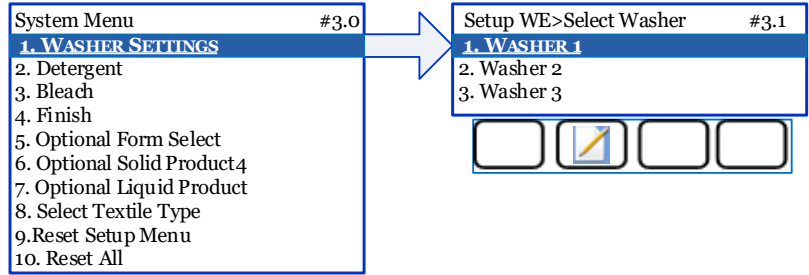

Submenu #3.1.1.1 Setup Menu>Washer 1>WE Name:
 Washer Name can only be set up using an Ecolab tablet or a mobile device.

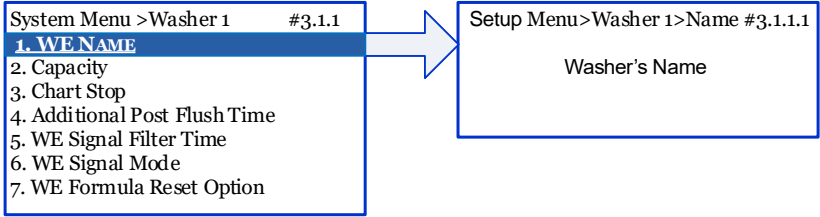

Submenu #3.1.1.2 System Menu>Washer 1> Capacity:
 Set up washer capacity. The wash formulae are entered into the system in Grams, and will be scaled to match the recommended dose for the washer capacity if the washer size is changed or the formulas are copied to another washer with a different capacity.

Example: If the recommended dose for Product X is 10 Gram/CWT, the Condor will scale doses for each washer based on washer capacity:

Washer Size	Dose
50-lb	5 Gram
200-lb	20 Gram

Use the Left/Right arrow keys to select the desired number (Range 22-135 lbs, Default 99 lbs).
 Press SK#3 <Save> to save selection.
 Press <Back> to cancel selection.

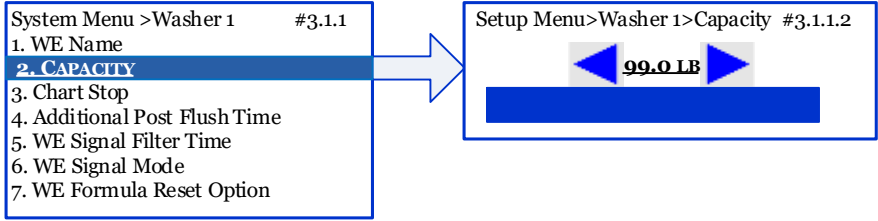

Submenu #3.1.1.3 System Menu>Washer 1> Chart Stop:

Set up Chart Stop feature for each washer, if desired. The default setup is No.
 Press SK#3 <Save> to save selection. Press <Back> to cancel selection.
 For information on Chart Stop Wiring, please refer to **Installation Manual**.

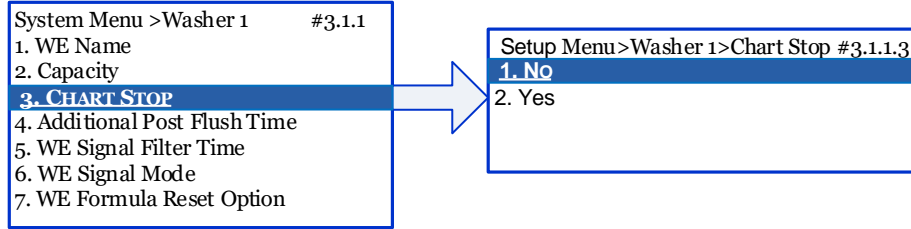

Submenu #3.1.1.4 System Menu>Washer 1> Additional Post Flush Time:

Set up the additional post-flush time for each washer. Flush time is dependent on several factors (distance from Main Dispenser to washer, elevation of flush tubing, water pressure, etc.) and it is important that a reasonable flush time is set.

⚠ WARNING
 An adequate post-flush time is very important to minimize the risk of cross-contamination between incompatible products. The post-flush time must be long enough to ensure that all product is completely flushed from the system.

Use the Left/Right arrow keys to set the desired flush time (Range 30-300, Default 30 seconds)
 Press SK#3 <Save> to save selection.
 Press <Back> to cancel selection.

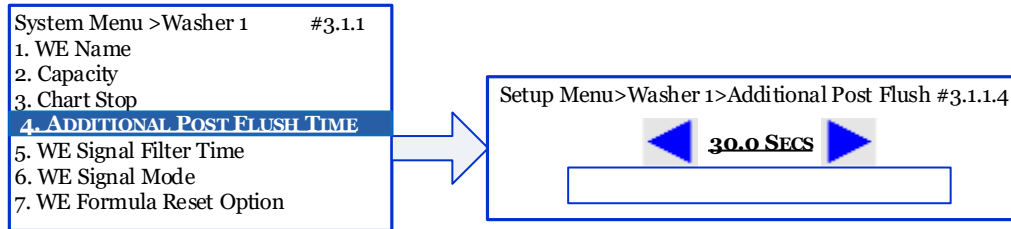

Submenu #3.1.1.5 System Menu>Washer 1>WE Signal Filter Time:

The Signal Filter Time for each washer is the minimum signal length required before controller deems it a valid signal. It is important to select a reasonable filter time (i.e. if filter time is too short stray voltage or electrical noise could register as a valid signal).

Use the Left/Right arrow keys to select the desired number (Range 0-29, Default 2 seconds)
 Press SK#3 <Save> to save selection.
 Press <Back> to cancel selection.

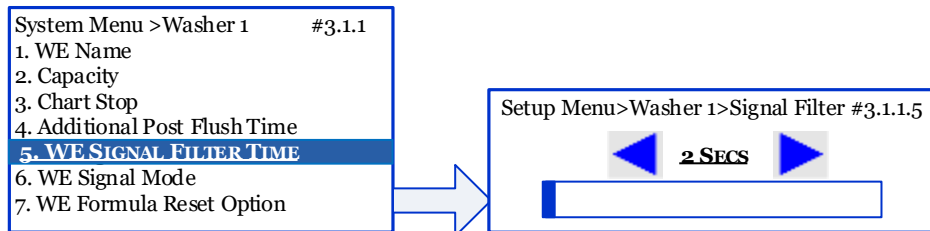

Submenu #3.1.1.6 System Menu>Washer 1>WE Signal Mode:

Set up washer in either standard signal mode or MicroMode.

- 1- **Standard Mode:** The system dispenses when it receives supply signals from the intended washer. Manual formula selection is required. Press SK#3 <Save> to save selection. Press <Back> to cancel selection.

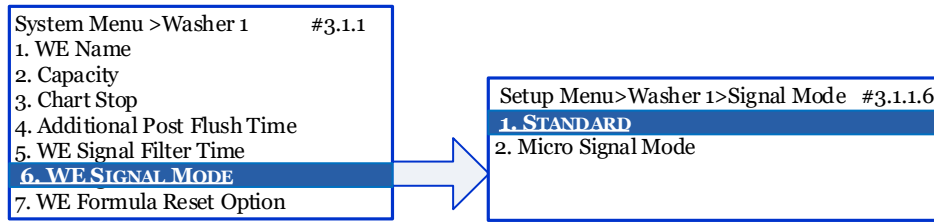

- 2- **Micro Mode:** Formula selection is automatically performed via an accurately-timed supply signal input from a fully-programmable microprocessor-controlled washer. Press SK#3 <Save> to save selection. Press <Back> to cancel selection.

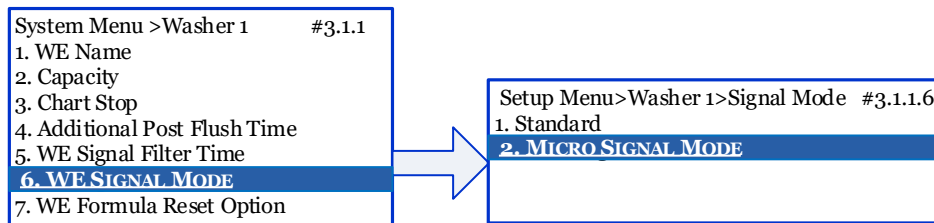

There are two equations used to calculate the MicroMode signal time (Input 1 ON time). The following table shows the MicroMode signal time for each formula considering these two equations:

Input 1 ON Time (seconds)		Formula Selected
T=2F+1	T= 5F	
3	5	Formula 1
5	10	Formula 2
7	15	Formula 3
9	20	Formula 4
11	25	Formula 5
13	30	Formula 6
15	35	Formula 7
17	40	Formula 8
19	45	Formula 9
21	50	Formula 10

The default equation is T=2F+1.

Press SK#2 <Edit> to select the desired MicroMode signal time equation. Press SK#3 <Save> to save selection. Press <Back> to cancel selection.

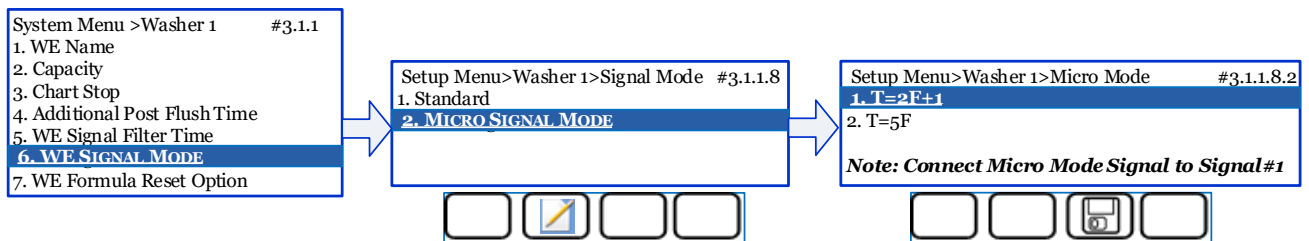

Refer to **Installation Manual** for information on **MicroMode Wiring**.

Submenu #3.1.1.9 System Menu>Washer 1>WE Formula Reset Option:

When this option is enabled, the washer formula will reset to the previously selected formula.

The Default setup is 'No'. Press <Back> to cancel selection. Press SK#3 <Save> to save selection.

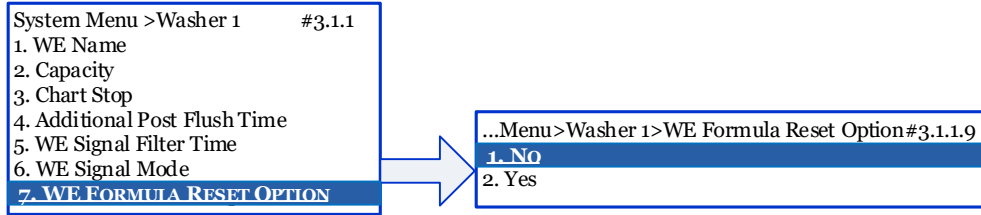

2.3.2 Submenu #3.2 System Menu>Detergent:

Select the detergent product and change the product factor.

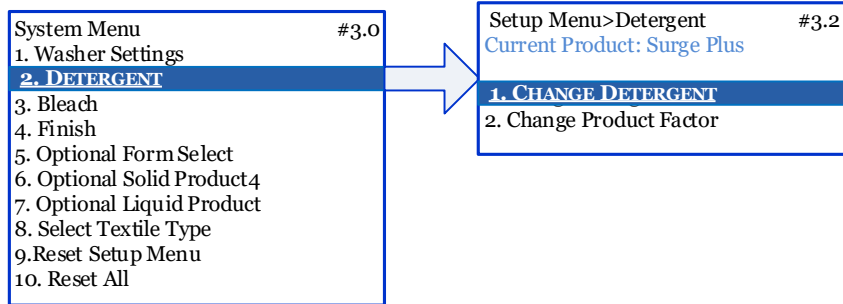

Submenu #3.2.1 Setup Menu> Detergent >Change Detergent:

Change detergent product.

Press SK#3 <Save> to save selection. Press <Back> to cancel selection.

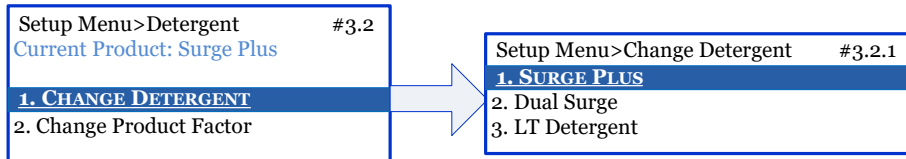

Submenu #3.2.2 Setup Menu> Detergent >Change Product Factor:

Change the selected detergent product factor.

Press SK#3 <Save> to save selection. Press <Back> to cancel selection.

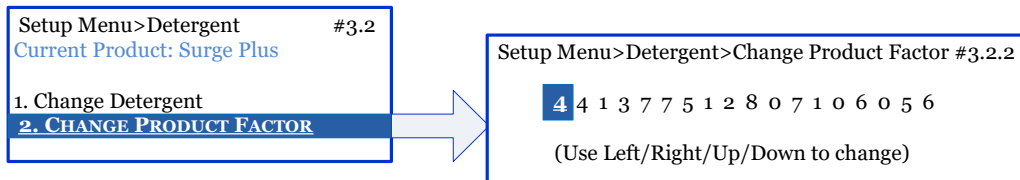

2.3.3 Submenu #3.3 System Menu>Bleach:

Select the bleach product and change the product factor

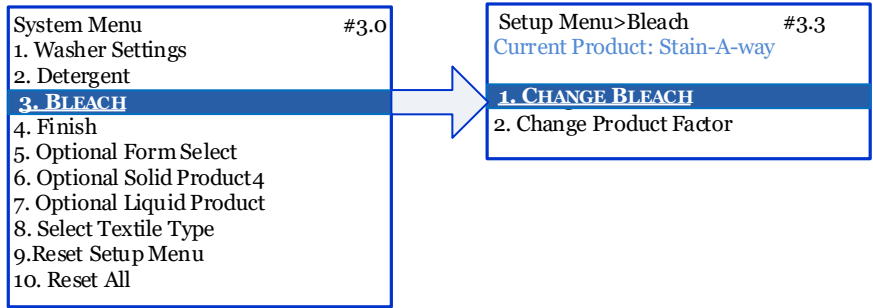

Submenu #3.3.1 Setup Menu> Bleach >Change Bleach:

Change Bleach product.
Press SK#3 <Save> to save selection. Press <Back> to cancel selection.

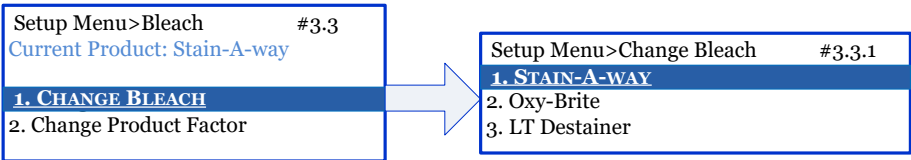

Submenu #3.3.2 Setup Menu> Bleach >Change Product Factor:

Change the selected bleach product factor.
Press SK#3 <Save> to save selection. Press <Back> to cancel selection.

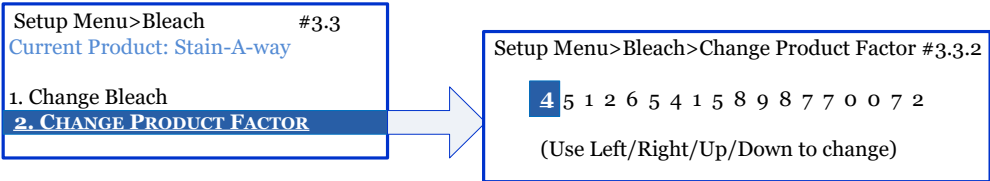

2.3.4 Submenu #3.4 System Menu>Finish:

Select the finish product and change the product factor

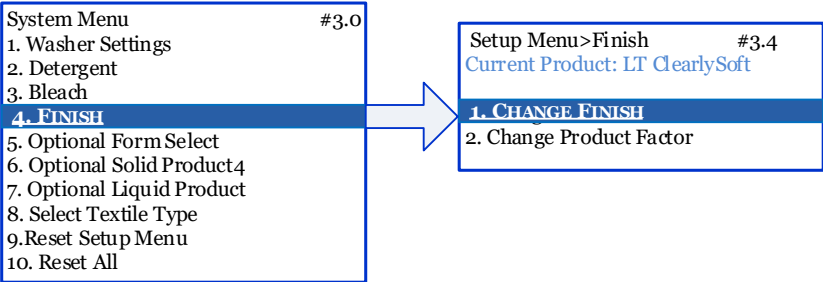

Submenu #3.4.1 Setup Menu> Finish >Change Finish:

Change Finish product.
Press SK#3 <Save> to save selection. Press <Back> to cancel selection.

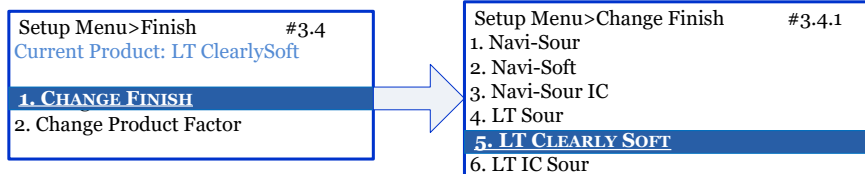

Submenu #3.4.2 Setup Menu> Finish >Change Product Factor:

Change the selected finish product factor.
 Press SK#3 <Save> to save selection. Press <Back> to cancel selection.

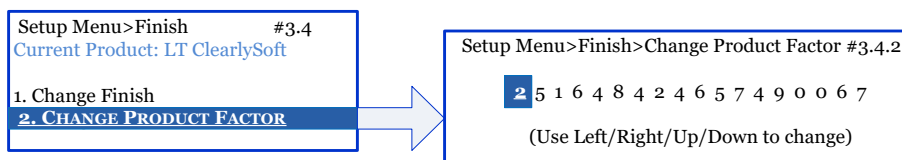

2.3.5 Submenu #3.5 System Menu>Optional Form Select:

The optional Formula Select module is required to activate this feature. Default setup is Yes.
 When FS is installed, formulae can be selected using the module on the front of the washers using the Up/Down/Enter keys. The FS screen will display any system errors.

If no formula select is installed, formulae must be selected from the Condor Controller. In this case, it is advised the controller be mounted in a central location convenient for accessing – or set up the washers in MicroMode for automatic formula selection (Refer to **Installation Manual**).

Use Up/Down arrow keys to highlight a selection.
 Press SK#3 <Save> to save selection.
 Press <Back> to cancel selection.

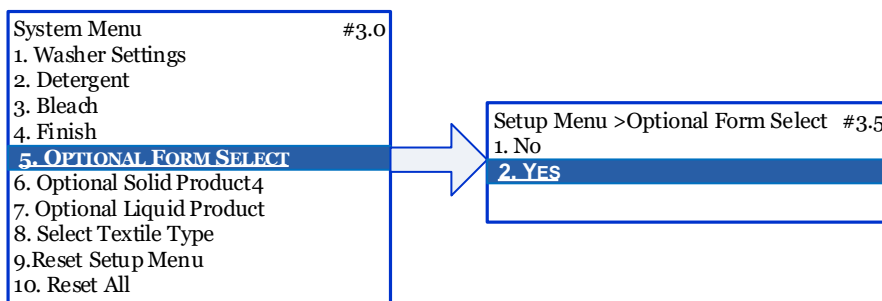

2.3.6 Submenu #3.6 System Menu>Optional Solid Product4:

Enable an optional solid forth product. Default setup is No.
 Use Up/Down arrow keys to highlight a selection.
 Press SK#3 <Save> to save selection.
 Press <Back> to cancel selection.

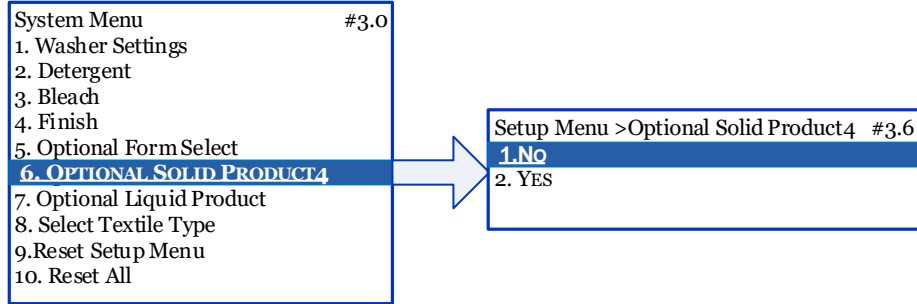

When select to enable the forth product:

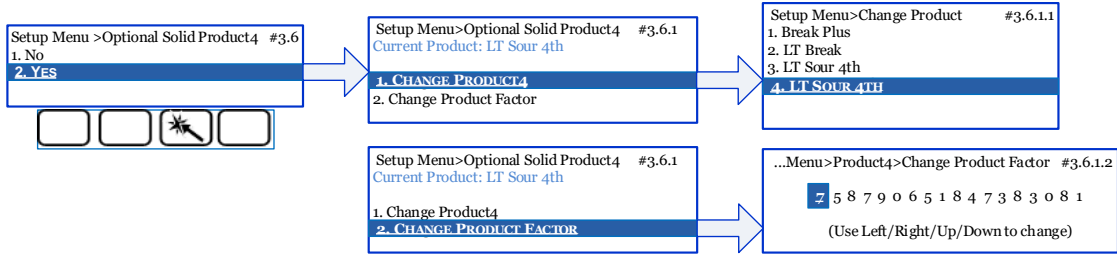

Press SK#3 <Save> to save selection.
Press <Back> to cancel selection.

2.3.7 Submenu #3.7 System Menu>Optional Liquid Product:

Enable the optional liquid product. Default setup is No.
Use Up/Down arrow keys to highlight a selection.
Press SK#3 <Save> to save selection.
Press <Back> to cancel selection.

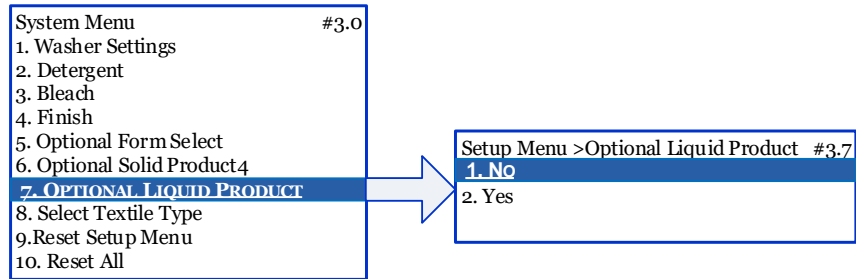

When select to enable the liquid product:

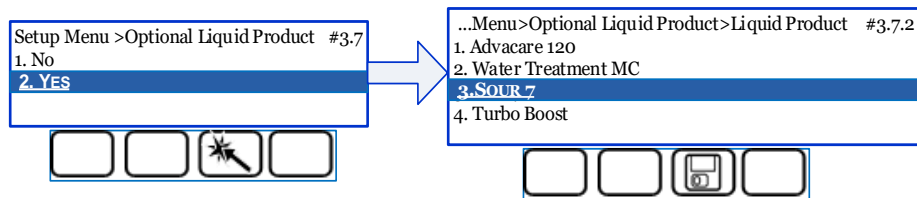

you can also map the washers to the liquid pumps by pressing on SK#2 <Signal Mode>. Choosing SK#3 <Reset> will unmap the liquid pumps, and choosing SK#2 <Edit Product> will allow remapping the pumps to the desired washers:

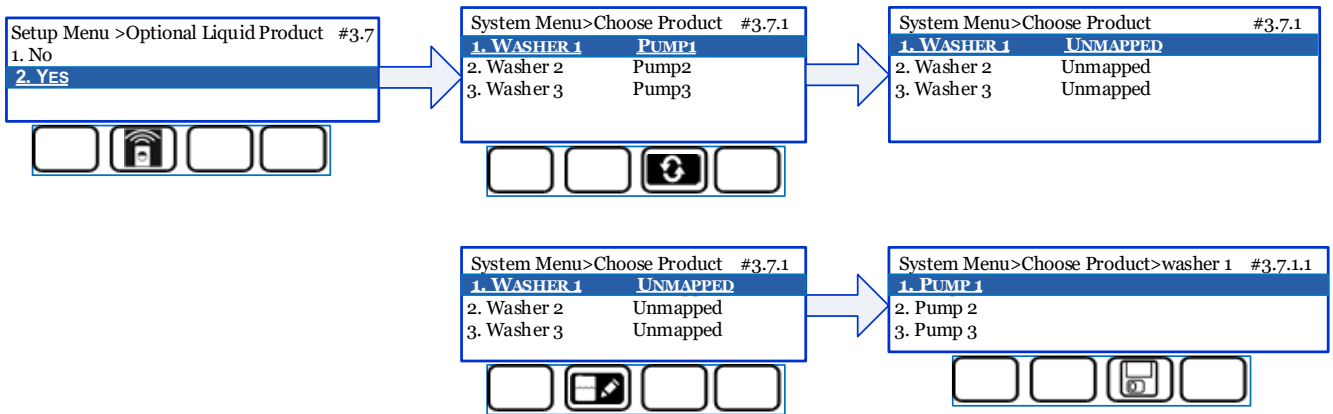

2.3.8 Submenu #3.8 System Menu>Select Textile Type:

A pre-programmed list of formulae (up to 15 formulae per region) has been default factory set inside the Condor controller and visible on screen #3.4. These factory defaulted formulae will be automatically loaded to each washer and synchronized with the Formula Select modules (if installed).

If a specific dose amount needs adjustment, select the <Edit> key on screen #3.9.1. If a formula is modified here, it will be loaded to all formulae in ALL washers. These amounts can be adjusted using the Left/Right keys.

Use Left/Right arrow keys to adjust formula amounts.

Press SK#3 <Save> to save selection.

Press <Back> to cancel selection.

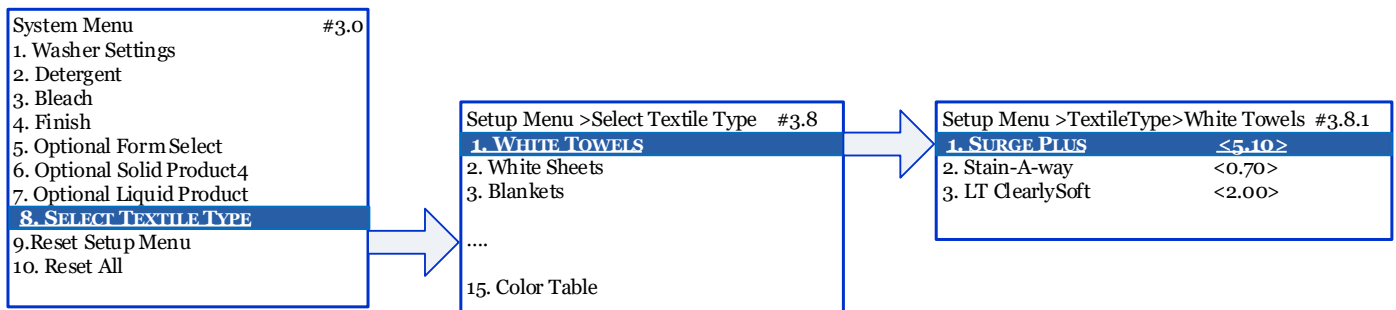

2.3.9 Submenu #3.9 System Menu>Reset Setup Menu

This function will reset the Setup Menus to factory settings, including textile type, formulae, and dose amounts.

Reset the Setup Menus to factory settings, including textile type formulae, and dose amounts.

Confirm your selection using SK#2 (No) or SK#3 (Yes).

Press <Back> to return to the previous screen.

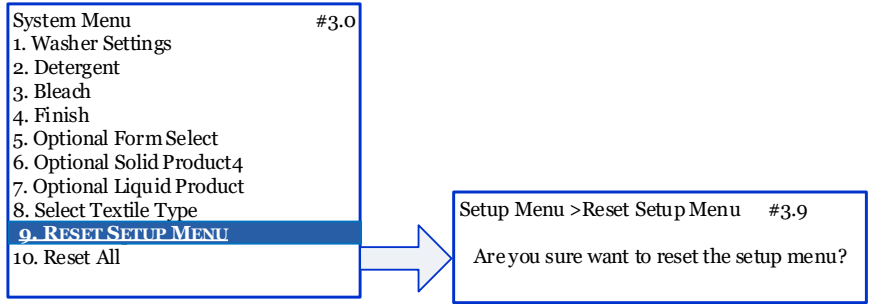

2.3.10 Submenu #3.10 System Menu>Reset All

Reset the entire Condor controller to factory settings.

Confirm your selection using SK#2 (No) or SK#3 (Yes). Press <Back> to return to the previous screen.

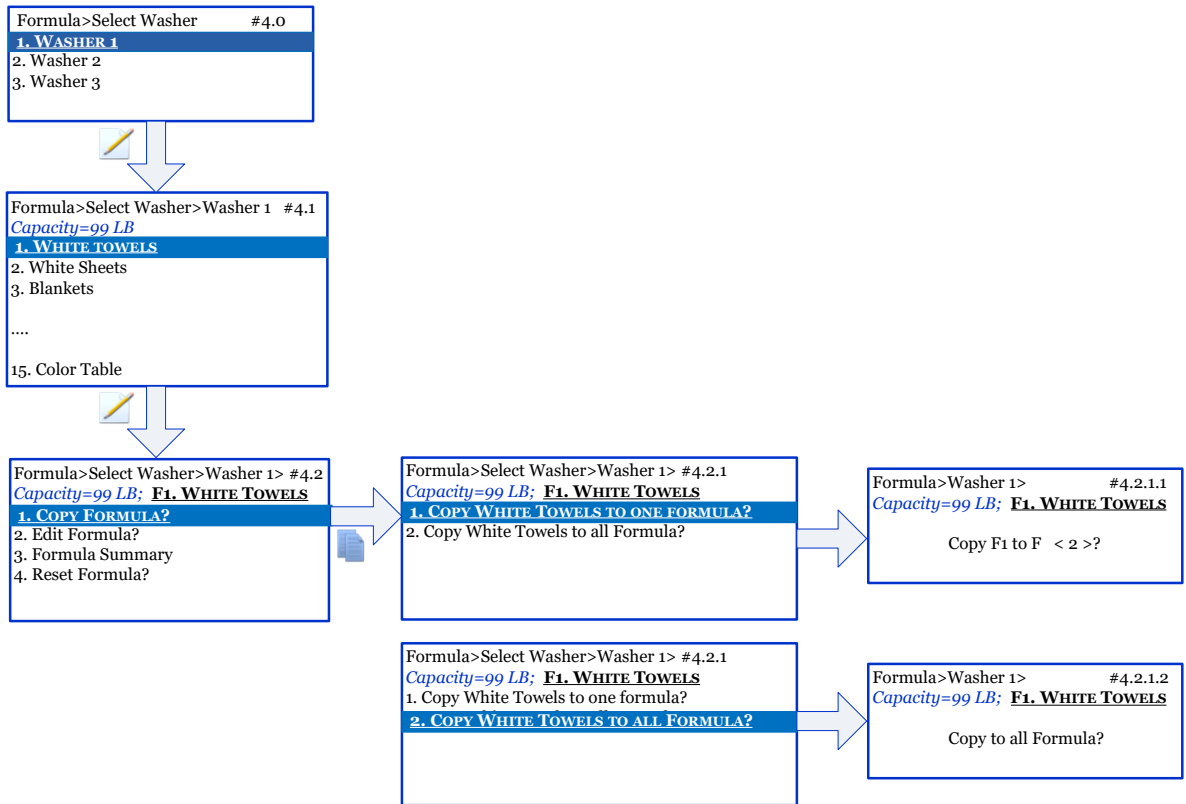
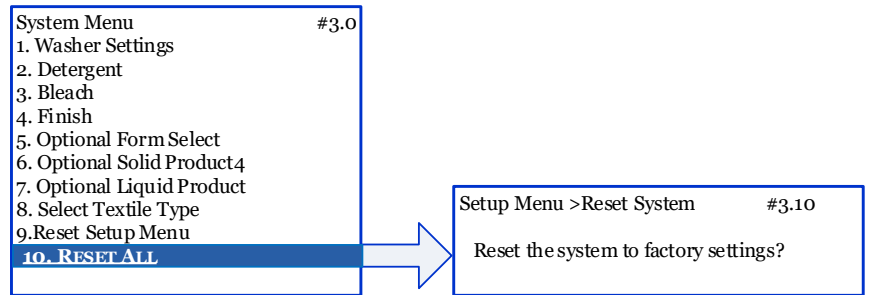

2.4 Submenu #4.0 Formula Menu

Formula programming options include programming/modifications of up to 15 Formulae, using up to 4 Solids and one liquid. Pump delays/product delays can be incorporated into the formula to add flexibility.

A formula can be copied to another formula, or all formulas can be copied from one washer to another washer.

Formula setup can also be performed on an Ecolab tablet or mobile device, and then downloaded to the controller. Press SK#2 <Edit> to select the desired washer.



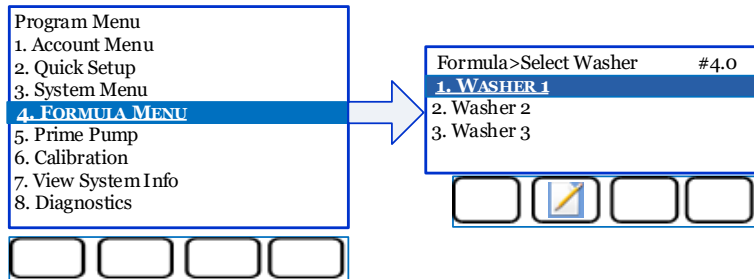

⚠ CAUTION

To avoid operator exposure to chemical products, the queue system will automatically cancel the final step of a wash formula if it is in queue (waiting) for longer than 3 minutes. If the final washer step includes a chemical dose, it is important that the washer step programmed length is greater than 3 minutes.



2.4.1 Submenu #4.0 Formula Menu --- Copy a Formula:

The screen map below details the steps required to copy a single formula to another formula or to all formulae. Highlight a washer using the Up/Down arrow keys to begin copying a formula.







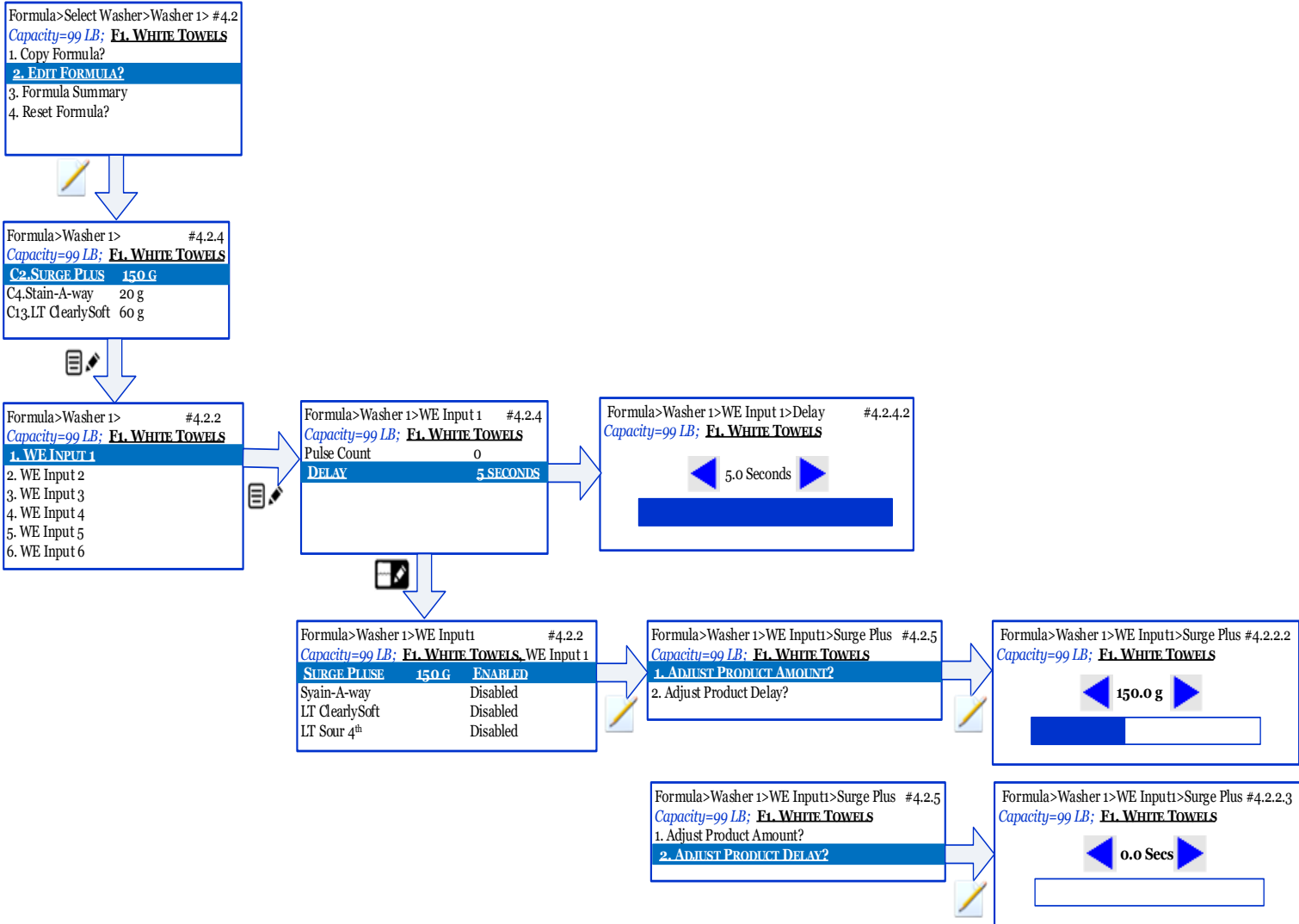

Screen	Description	
4.0	Select a washer	
		Proceed to edit/copy formulae information for the selected washer.
4.1	Select a formulae to copy or reset all formulae to factory default settings.	
		Reset all formulae to factory default settings
		Proceed to edit/copy selected formula.
4.2	From this screen the operator can Copy, Edit and Reset Formulae. It also allows the user to pull up a formula summary.	
		Proceed to copy formula
4.2.1	Copy Formula Copy Formula to Another Formula: Copies highlighted formula to a destination formula selected by operator. Copy Formula to ALL Formulae: Copies highlighted formula to ALL formulae for specified washer.	
	<ENTER>	Select highlighted option
4.2.1.1		Confirm selection
4.2.1.2		

2.4.2 Submenu #4.0 Formula Menu --- Edit a Formula (with Chart Stop Disabled)

The screen map below details the steps required to navigate the “edit formula” sub-menus.



Screen	Description
4.2	From this screen the operator can Copy, Edit and Reset Formulae. It also allows the user to pull up a formula summary.
	 Proceed to Edit Formula
4.2.4	<p align="center">Summary of Pre-Programmed Formulae</p> <p>Each product that has been programmed into the formula is shown with the formula amount scaled to the washer capacity.</p> <p>Cx = Chemical X</p>

		Proceed to edit wash steps
		Remove all wash steps (clear the formula – zero products and product amounts)
	Assign Product to Washer Signals	
4.2.2	There are six washer inputs available, WE Input 1-6 (corresponding to 6 washer chemical signals).	
		Proceed to edit selected wash step
		Disable all products assigned to highlighted wash step. Note: This key is only made available if there is product assigned to the step.
	Delay	
4.2.4	Delay (Default = 5s; Range = 0-600s): The delay can be adjusted to insert a pause between when the washer signal is successfully received and validated, and when the system begins dosing of the assigned product. This is essentially an adjustment of the “pre-flush”.	
		Proceed to edit/assign product and product amount to wash step
	<ENTER>	Edit “Pulse Count” or “Delay”
	Enabled/Disabled Products	
4.2.2	In the screen shown above, doses are displayed for WE Input #1. One product is set up as Enabled, (to be dosed) when Signal 1 is received from Washer 1. The remaining products are all disabled and will not be dosed.	
	Note1: For each step, or each washer signal, up to 3 solid and 1 liquid products may be Enabled (to be dosed). Additional hard wiring is not necessary to any of the pumps or signals on the MSI module.	
	Note2: Locked products cannot be Enabled in the same step (ex. Bleach and Sour)	
		Proceed to edit product amount and product delay for the highlighted product.
		Remove product from wash step. Note: This key is only made available if the product is Enabled.
	Product Amount and Product Delay	
4.2.5	Adjust Product Amount (Range 0-297 g)	
	Adjust Product Delay (Default = 0s; Range = 0 - 900s): This allows multiple product doses in the same wash step. If the product delays in a step are all set to zero, all solid products will be dosed one after other immediately after the signal is successfully received and validated from the washer. A Product Delay can be set to assign delay timing to each dose in the wash step, and each product will wait for the delay time before it is individually dosed and flushed.	
		Proceed to “Adjust Product Amount” or “Adjust Product Delay”
4.2.2.2		Save Setting
4.2.2.3		

2.4.3 Submenu #4.0 Formula Menu --- Edit a Formula (Chart Stop Enabled)

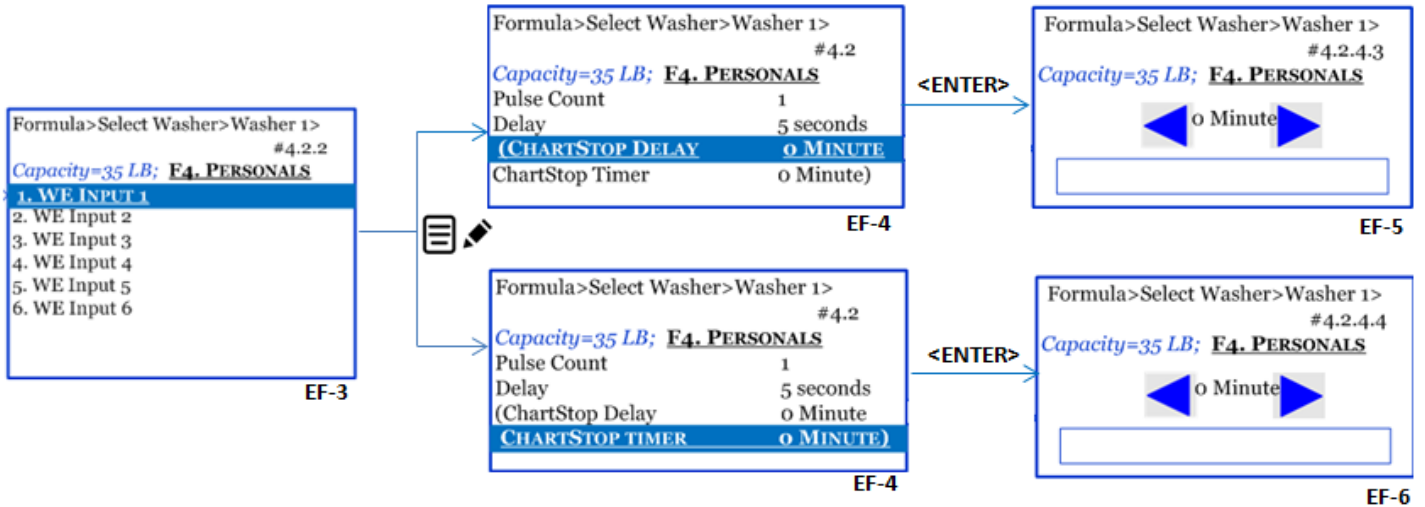

Chart Stop (or Machine Hold) can assist with extending chemical contact time in the wash cycle. With Chart Stop Enabled, screen EF-4 from the previous section will now appear with 2 additional line items:



Screen	Description	
4.2 (CHART STOP)	Edit Formula –with Chart Stop Enabled	
	Chart Stop (or Machine Hold) extends chemical contact time in the wash cycles. Refer to Chart Stop Wiring in the installation manual for wiring recommendations.	
	<p>Chart Stop Delay (Default = 0 minutes; Range = 0 – 60 minutes): Programming this type of delay will insert a pause between when the validated chemical signal is received from the washer, and when the product begins its dose. If Chart Stop Delay = 0 minutes, the product will be dosed immediately after the washer signal is received and validated.</p> <p>Chart Stop Timer (Default = 0 minutes; Range = 0 – 60 minutes): This timer will put the washer on hold between doses. The timer begins after a product has been dosed.</p>	
	<ENTER>	Edit Chart Stop Delay or Chart Stop Timer
		Proceed to edit/assign product and product amount to wash step
		*Continue from Screen EF-5 in the previous section.
4.2.4.3 (CHART STOP)		Save Selection
4.2.4.4 (CHART STOP)		

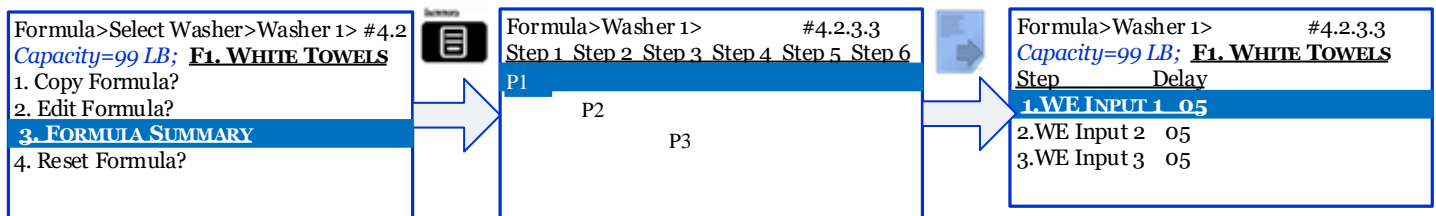

2.4.4 Submenu #4.0 Formula Menu --- Formula Summary

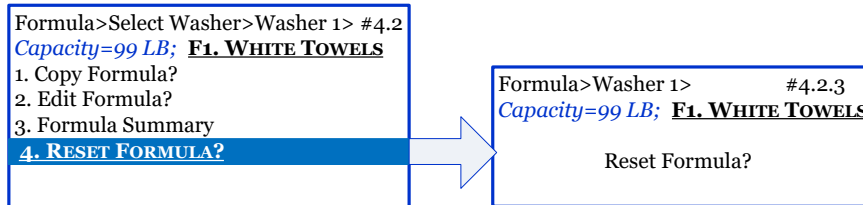

Screen	Description	
4.2	From this screen the operator can Copy, Edit and Reset Formulae. It also allows the user to pull up a formula summary.	
		View formula summary
4.2.3.3	<p align="center">Formula Summary</p> <p>This screen lists the products assigned to each wash step (steps 1-6).</p> <p>For example, in the screen above P1 is assigned to washer Step 1. Therefore, once S1 has been validated, P1 will be dosed into the wash wheel. P2 is assigned to washer Step 2, and will be dosed once S2 has been validated. P3 is assigned to washer Step 3, and will be dosed once S3 has been validated. There is no product assigned to washer Steps 4-6.</p>	
		View more information
4.2.3.3	<p align="center">Formula Summary – Additional Information</p> <p>This screen displays the Delays (in seconds), Chart Stop Delays, and Chart Stop Timers (if Chart Stop is Enabled) for up to 6 wash steps (WE Input 1-6).</p> <p>Note: All Chart Stop Delay and Timers are set to 00 (minutes).</p>	

2.4.5 Submenu #4.0 Formula Menu --- Reset Formula



Screen	Description	
4.2	From this screen the operator can Copy, Edit and Reset Formulae. It also allows the user to pull up a formula summary.	
		Reset selected formula to factory default settings. A pop-up screen will appear and ask the user to confirm the selection.
4.2.3		Confirm Selection

2.5 Submenu #5.0 Prime Pump – Used only for optional liquid pumps

CAUTION

Priming liquid pumps delivers chemical product and flush water to the washing machine. Ensure washer is idle and empty prior to performing a liquid pump prime and ensure the chemistry is properly flushed and drained from the washing machine after the procedure.

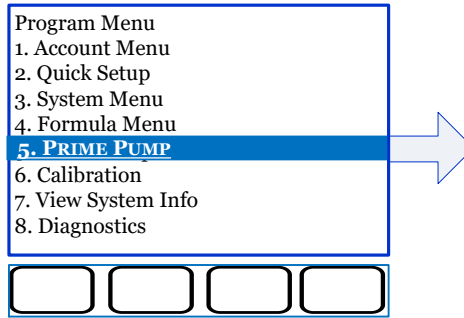

2.5.1 Submenu #5.1 Prime Pump>Prime Pump

Prime a product to purge air from the product pickup tubes.

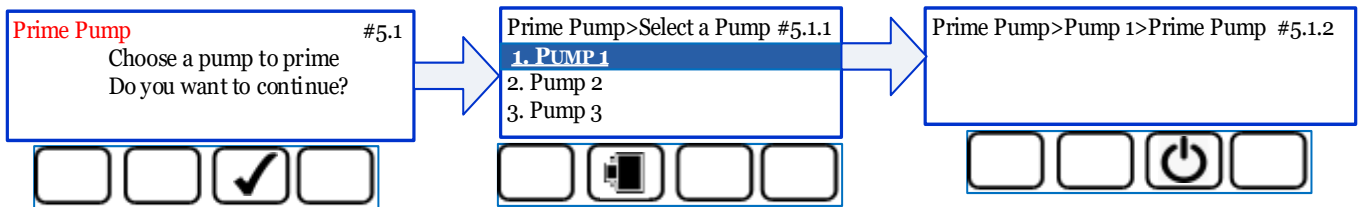

Screen	Description	
5.1	User is informed of the priming procedure.	
	Note: Primed product will be directed to the washer.	
	<YES> 	Continue to Prime Pump
5.1.1	Select a Pump	
	The user is instructed to choose a particular pump (#1 - #3) to prime	
	<ENTER>	Select Pump
5.1.2	Begin Prime	
	Once the pump has been selected, the user can begin priming. Maximum prime time is 30 seconds. A mandatory 30 second flush will start at the end of the 30 second prime or if the Stop command is pressed. If product has not reached pump head after a 30 second prime, repeat procedure.	
		Activate pump prime
		Stop pump prime (when product reaches pump head)

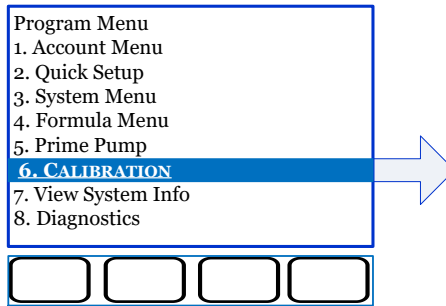

2.6 Submenu #6.0 Calibration– Used only for optional liquid pumps

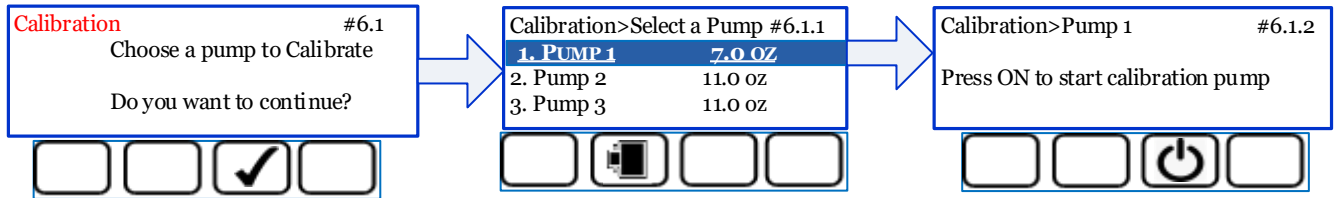

2.6.1 Submenu #6.1 Calibration>Select Pump

Calibration must be performed upon system installation and can also be performed periodically to verify the pump dosing is maintaining accuracy. Once activated, there will be a 5 second delay followed by the pump activating for 60 seconds. At the end of the 60 seconds, the controller will prompt the user to input the amount of product dispensed.



Screen	Description
6.1	Choose a Pump to Calibrate
	<YES> Continue to Calibrate
6.1.1	Select a Pump The user is instructed to choose a particular pump (#1 - #3) to calibrate. Pre-calibrated values have been factory-set for each type of product and pump. After the calibration, the new calibrated value will be entered, saved, and displayed for reference on the next visit.
	<ENTER> Select Pump
6.1.2	Begin Calibration Once a pump has been selected, the operator can begin/stop calibration. The user can start/stop the pump as needed; however, the total calibration time must be equal to 60 seconds.
	 Activate pump
	 Stop pump
6.1.3	Enter Calibrated Value When 60 seconds of calibration is complete, the controller will prompt the user to enter the new calibrated value. A mandatory 30 second flush will start after the calibration value is saved. If no value is entered and saved after 300 seconds of idle time, the system will automatically revert back to the last calibrated value and start a 30 second flush.

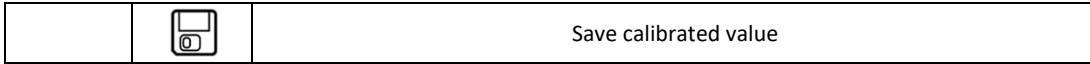

2.7 Submenu #7.0 View System Info

This sub-menu offers extended information logged for the entire system, and can be broken down by each system component for each washer. It will also include software revision information for each of the connected modules (MSI, FS, IO, Condor controller), Load Count histories/Time & Date stamping, and clearing options (i.e. error logs, and load counts).

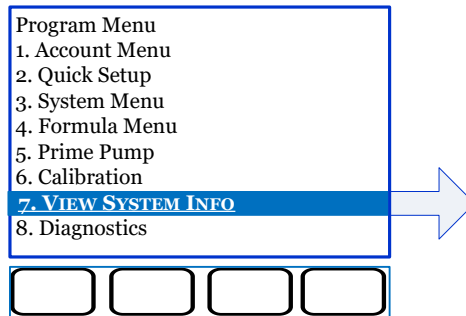

NOTE

When an Ecolab tablet or mobile device is connected to the Condor controller, the software revision of each connected module will be compared to the latest software releases from the Ecolab design team. A flag will be raised and confirmation of a software update process will be displayed on the Tablet (if necessary).

2.7.1. Submenu #7.1 View System Info>Last Visit

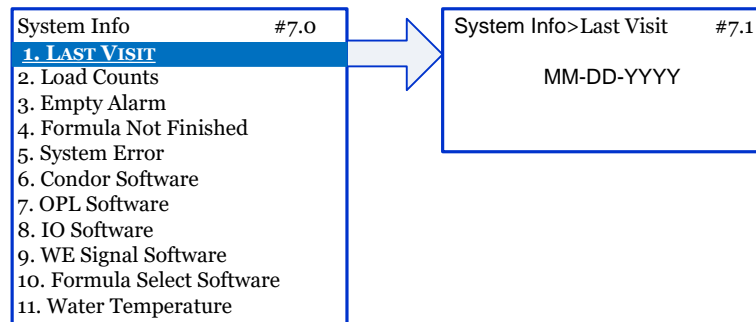



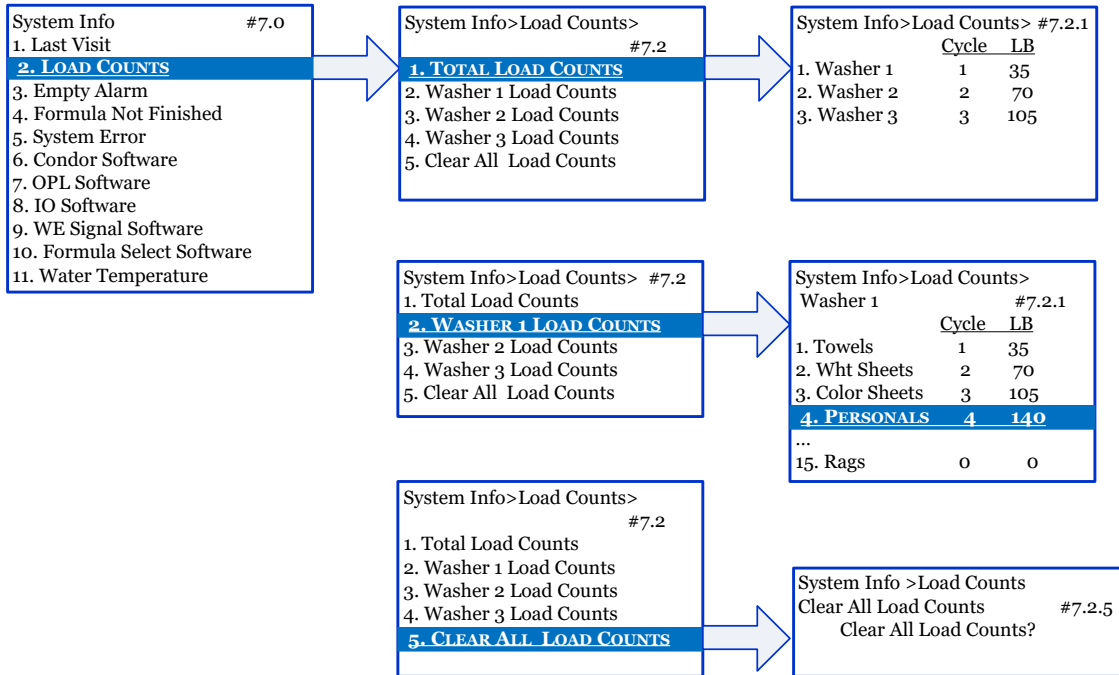

Screen #7.1 displays the date from the last visit. A visit is logged when the password protected menu is accessed or the Condor Controller is connected to an Ecolab tablet or mobile device.

Press <Back> to return to the previous screen.

2.7.2. Submenu #7.2 View System Info>Load Counts



Screen	Description
	Load Counts
7.2	Select load counts to view total system load counts, load counts for each washer, or to clear load counts.
<ENTER>	Proceed to view load counts
	Logged Load Counts
7.2	Load counts may be viewed at the system level (i.e. Total Load Counts) or individually for each of the 3 washers. Load counts for each washer will be further broken down to Load Counts for each formula.
<ENTER>	Use Up/Down arrow keys to scroll to desired load counts or clear load counts.
	Total Load Counts
7.2.1	Total load counts displayed for each of the 3 washers.
	Narrow down Load Counts for a certain period of time (provided the controller clock has been properly set up – Quick Setup > 4. Date & Time)
	Clear all load counts
	Washer Load Counts
7.2.2	For the selected washer, load counts for each of the 15 formulae are shown.
	Narrow down Load Counts for a certain period of time (provided the controller clock has been properly set up – Quick Setup > 4. Date & Time)

		Clear washer load counts
7.2.5	Clear Load Counts	
	This screen allows the user to clear all Load Counts for the entire system. Confirm selection.	
	<YES>	Clear all load counts

2.7.3. Submenu #7.3 View System Info>Empty Alarm

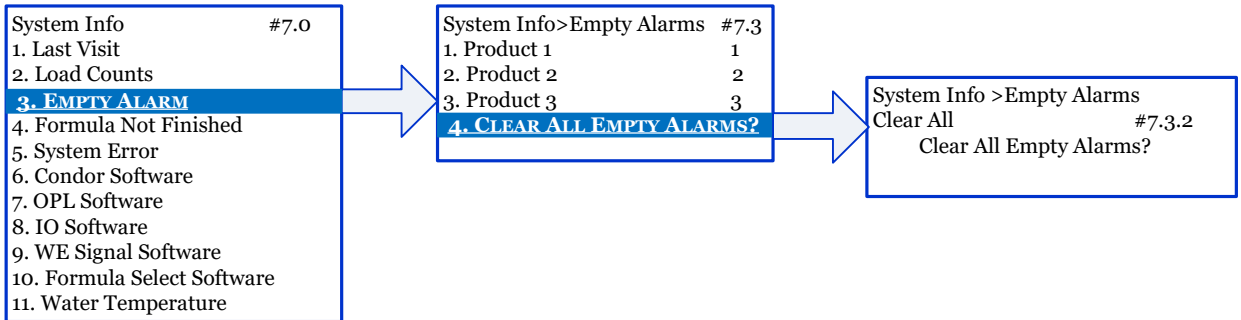

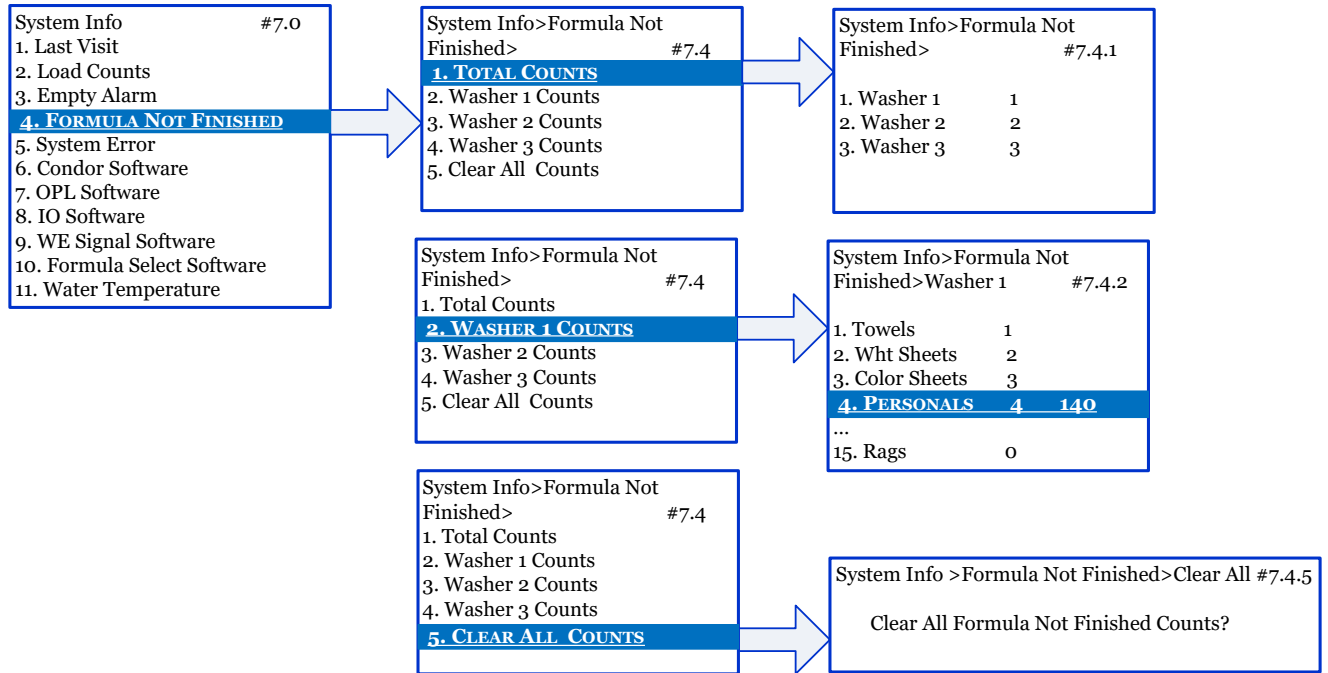

Screen	Description	
7.0	System Info	
	Proceeding from here will allow the user to view or clear empty alarms for each product.	
	<ENTER>	Proceed to view empty alarms for each product
7.3	Empty Alarms	
	Logged Empty Alarms are displayed for each of the 4 products. An option is also available to clear Empty Alarms for the entire system.	
		Narrow down Empty Alarms for a certain period of time (provided the controller clock has been properly set up – Quick Setup > 4. Date & Time)
7.3.2	Confirm Clear Empty Alarms	
	Select Yes or No to confirm the selection	
	<YES>	Confirm clear Empty Alarms

2.7.4. Submenu #7.4 View System Info>Formula Not Finished







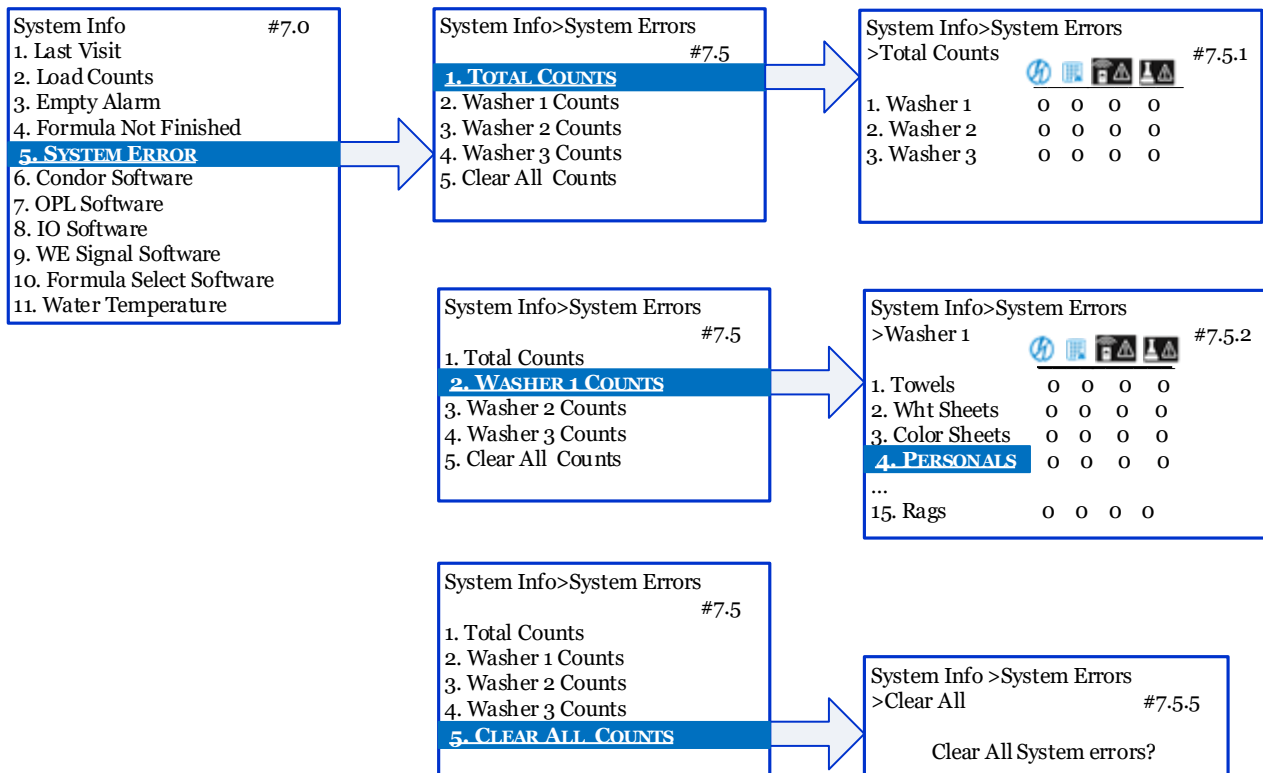

Screen	Description	
System Info		
7.0	Proceeding from here will allow the user to view and clear Formula Not Finished alarms for each formula.	
	<ENTER>	Proceed to view or clear Formula Not Finished alarms for each product
Formula Not Finished Alarms		
7.4	Formula Not Finished alarms may be viewed at the system level (i.e. Total Formula Not Finished alarms) or individually for each of the 3 washers. Formula Not Finished alarms for each washer will be further broken down to Formula Not Finished for each formula. An option is also available for clearing these alarms at the system level.	
	Formula Not Finished is defined as a non-complete formula, and could be due to the following: <ul style="list-style-type: none"> • Missing a chemical signal request from the washer (washer may have been forwarded) • Last chemical request signal is received from the washer before other steps have been completed • Extended time-out – no signal is received 	
	Formula Not Finished is a powerful tool for troubleshooting the washer.	
		Narrow down Formula Not Finished alarms for a certain period of time (provided the controller clock has been properly set up – Quick Setup > 4. Date & Time)
Total Formula Not Finished Counts		
7.4.1	Total Formula Not Finished alarms are displayed for each washer.	

		Narrow down Formula Not Finished alarms for a certain period of time (provided the controller clock has been properly set up – Quick Setup > 4. Date & Time)
7.4.2	Washer Formula Not Finished Counts	
	For the selected washer, Formula Not Finished alarms are shown for each of the 15 formulae.	
		Narrow down Formula Not Finished alarms for a certain period of time (provided the controller clock has been properly set up – Quick Setup > 4. Date & Time)
7.4.5	Confirm Clear Formula Not Finished Alarms	
	Clears Formula Not Finished alarms for the entire system.	
	<YES>	Confirm clear Formula Not Finished alarms.

2.7.5. Submenu #7.5 View System Info>System Errors



Screen	Description	
7.0	System Info	
	Proceeding from here will allow the user to view and clear System Errors for the system as a whole, or broken down for each of the 3 washers.	
	<ENTER>	Proceed to view or clear System Errors
7.5	System Errors	
	There are several types of System Errors that are logged by the system. In the following screens, a matrix is displayed with icons assigned to each error. These are defined as follows:	
	A.	 Unexpected power down reset error
	B.	 Communication Error – I/O Module
	C.	 Communication Error – MSI Module
D.	 Communication Error – FS Module	
	<ENTER>	Proceed to view System Errors
	Total System Error Counts	See description of System Errors above.
	 <small>Time Frame</small>	Narrow down System Errors for a certain period of time (provided the controller clock has been properly set up – Quick Setup > 4. Date & Time)
7.5.1	Washer System Error Counts	
	For the selected washer, System Errors are shown for each of the 15 formulae.	
	 <small>Time Frame</small>	Narrow down System Errors for a certain period of time (provided the controller clock has been properly set up – Quick Setup > 4. Date & Time)
7.5.2	Confirm Clear System Errors	
	Clears System Errors for the entire system.	
	<YES>	Confirm selection

2.7.6. Submenu #7.6 View System Info>Condor Software

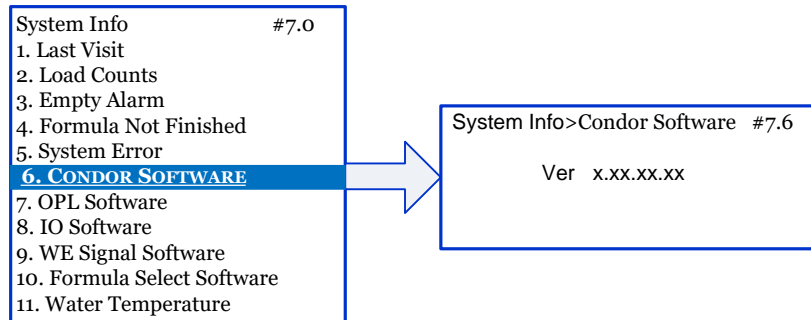

From this screen the software revision number for the main core of the Condor controller can be viewed. To obtain this information, select SK#3 <TEST>. It is normal to experience a 30 second or more delay, with an animated busy timer as the system queries for information.

2.7.7. Submenu #7.7 View System Info>OPL Software

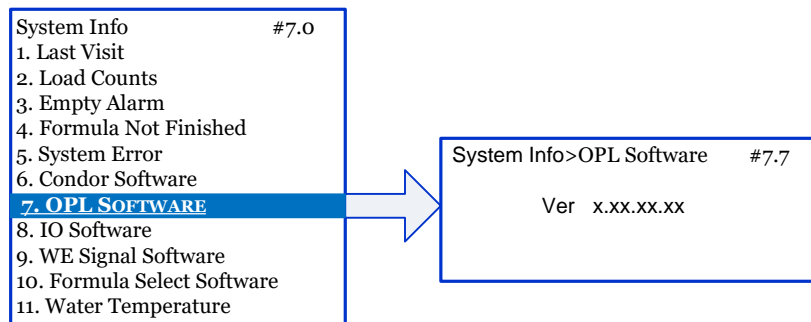

From this screen the software revision number for OPL application on the Condor controller can be viewed. To obtain this information, select SK#3 <TEST>. It is normal to experience a 30 second or more delay, with an animated busy timer as the system queries for information.

2.7.8. Submenu #7.8 View System Info>IO Software

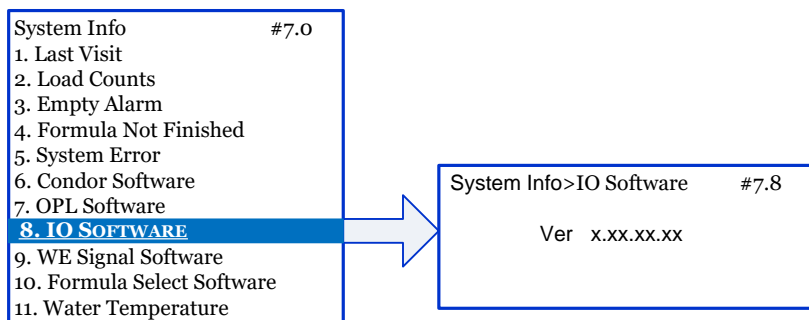

From this screen the software revision number for the main Input/Output (IO) module controlling the discrete components can be viewed. To obtain this information, select SK#3 <TEST>. It is normal to experience a 30 second or more delay, with an animated busy timer as the system queries for information.

2.7.9. Submenu #7.9 View System Info>WE Signal Software

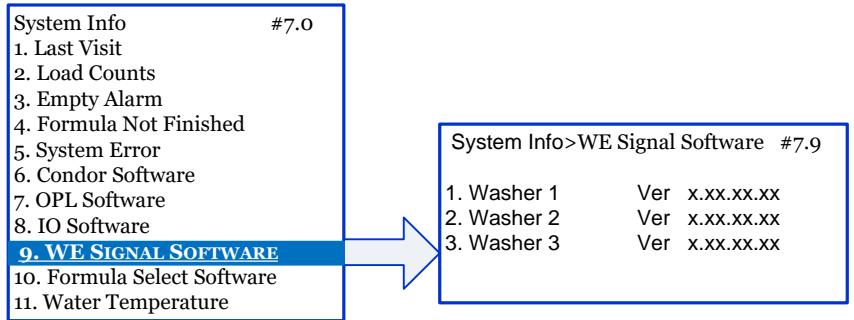

From this screen the software revision number for the MSI modules connected to the Condor controller can be viewed. To obtain this information, select SK#3 <TEST>. It is normal to experience a 30 second or more delay, with an animated busy timer as the system queries for information.

2.7.10. Submenu #7.10 View System Info>Formula Select Software

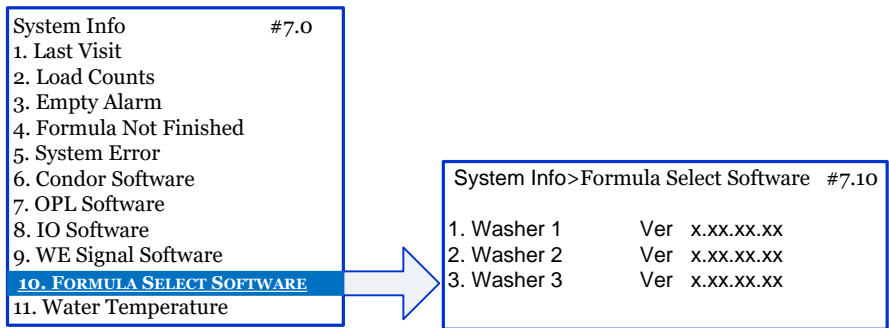

From this screen the software revision number for the FS modules connected to the Condor controller can be viewed. To obtain this information, select SK#3 <TEST>. It is normal to experience a 30 second or more delay, with an animated busy timer as the system queries for information.

2.7.11. Submenu #7.11 View System Info>Water Temperature

This menu allows the user to view the out-of-range temperature occurrences for each product and the average system temperature.

- System Info #7.0
- 1. Last Visit
- 2. Load Counts
- 3. Empty Alarm
- 4. Formula Not Finished
- 5. System Error
- 6. Condor Software
- 7. OPL Software
- 8. IO Software
- 9. WE Signal Software
- 10. Formula Select Software
- 11. WATER TEMPERATURE**

- System Info>Water Temperature #7.11
- 1. TOTAL POCKETS TEMPERATURE**
- 2. Average System Temperature

System Info>Water Temperature #7.11.1		
	Above 150 F	Below 100 F
1. (Detergent)	0	0
2. (Bleach)	0	0
3. (Finish)	0	0
4. (Product4)	0	0

- System Info>Water Temperature #7.11
- 1. Total Pockets Temperature
- 2. AVERAGE SYSTEM TEMPERATURE**

System Info>Water Temperature #7.11.2

Average : 0 F

Note:



You can Narrow down Water Temperature values for a certain period of time (provided the controller clock has been properly set up – **Quick Setup > 4. Date & Time**)

2.8. Submenu #8.0 Diagnostics



- Program Menu
- 1. Account Menu
- 2. Quick Setup
- 3. System Menu
- 4. Formula Menu
- 5. Prime Pump
- 6. Calibration
- 7. View System Info
- 8. DIAGNOSTICS**



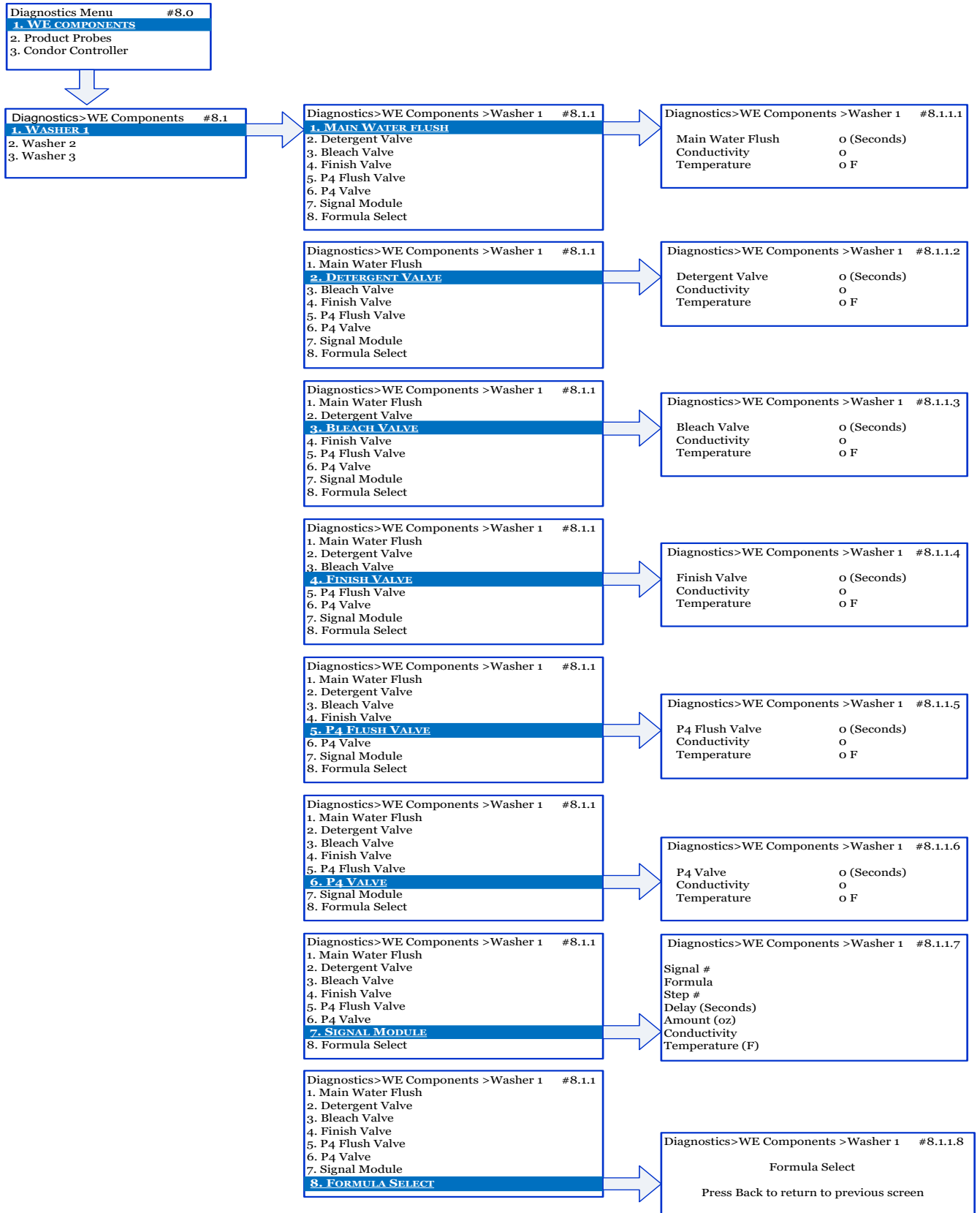

2.8.1. Submenu #8.1 Diagnostics>WE Components

The Diagnostics Menu consists of 3 sub-menus allowing for functional verification of all modules connected to the Condor controller, and all discrete components controlled by the IO board (main water valve, washer valves, product valves, etc.). **Some diagnostic functions can only be performed when no formulas are selected on any washer.**





Screen	Description	
8.0	Diagnostics Menu	
	The Diagnostics Menu consists of 3 sub-menus allowing for functional verification of all modules connected to the Condor controller, and all discrete components controlled by the IO board (water valve, product valves, machine valves, etc).	
	<ENTER>	Proceed with WE component diagnostics
8.1	Select a Washer	
	<ENTER>	Select washer
8.1.1	WE Component Diagnostics	
	Main water Flush	Activate main water flush valve (at inlet of flush manifold) for 60 seconds. This 60 second flush will be directed to the selected washer valve.
	Product Flush	Activate product (Detergent, Bleach, or Finish) flush valve (at inlet of flush manifold) for 60 seconds. This 60 second flush will be directed to the selected washer valve and will be followed by 30 seconds of post flush.
	Optional 4th Product Flush	Activate 4 th product valve for 60 seconds. This 60 second flush will be directed to the selected washer valve and will be followed by 30 seconds of post flush.
	Signal Mode	This screen will allow the user to monitor the status of the washer signal as it is sent from the washer, as well as verify the proper step (amount and delay) is programmed into the formula. NOTE: A formula must be selected prior to the signal being triggered from the washer. Similar information can be seen from the main customer screen, refer to section 1.2 Customer Screens
	Formula Select	This screen allows the user to verify the communication status of the Formula Select module on the selected washer (if present).
	<ENTER>	Proceed with selection.
8.1.1.1	Activate Main water Flush: Perform 60 second water flush to selected washer.	
8.1.1.2	Activate Product valve: Perform 60 second product dispense to selected washer. This can be start/stopped at any time and will be followed by 30 seconds post flush.	
8.1.1.3	Product Info: This screen will allow the user to monitor the values of conductivity and temperature.	
8.1.1.4	No formulas can be active to be able to perform these functions.	
8.1.1.5		Activate the selected valve.
8.1.1.6		Deactivate the selected valve.
8.1.1.7	Signal Monitoring	
	Observe this screen during a wash cycle. If a signal is present, the following information will be displayed: <ul style="list-style-type: none"> • Signal # • Formula • Step # • Delay • Amount (g) • Conductivity • Temperature 	

Test Formula Select Communication	
8.1.1.8	Wait for a Pass/Fail message on the Condor Controller, as well as a “Diagnostic String” message displayed on the bottom line of the FS screen. This additional information will allow the user to verify the address setting to each of the FS modules is correct.
	The test must be deactivated before leaving this screen. If not deactivated, the “Diagnostic String” message will remain displayed on the FS screen. This message does not affect the functionality of the system.
	 Test FS communication
 Deactivate Test	

2.8.2. Submenu #8.2 Diagnostics>Product Probes- if liquids are used.

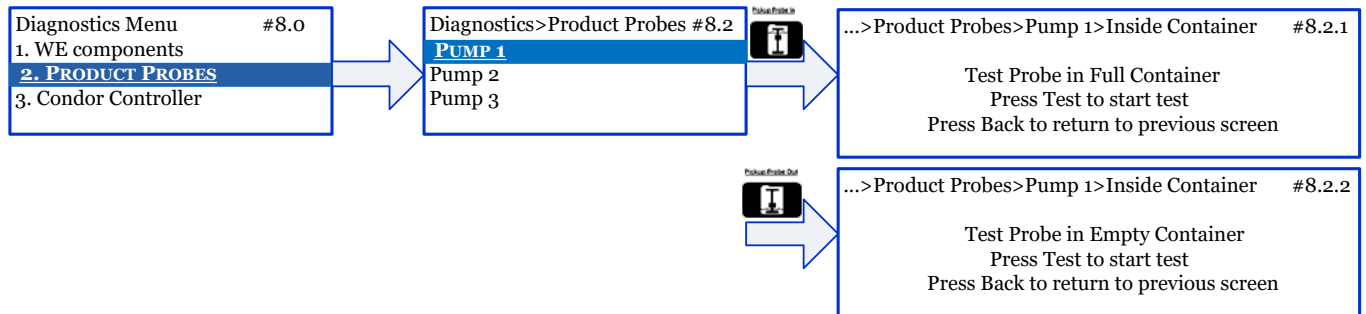
This test is only available when Optional Liquid Product is enabled and no formulas are active.



Screen	Description
8.0	Diagnostics Menu The Diagnostics Menu consists of 3 sub-menus allowing for functional verification of all modules connected to the Condor controller, and all discrete components controlled by the I/O board (water valve, product valves, machine valves, etc).
	<ENTER> Proceed with Product Probe diagnostics
8.2	Select a Pump (product) Select 1 of the 3 available pumps to test the pick-up probe assigned to that particular product.
	<ENTER> Select pump (product)
8.2.1	Test Probe This screen instructs the user to start the test and wait for a Pass/Fail message. The product pickup probe has a float switch at the end, which will be pushed up when placed in a full container (switch is read as “open” position). However when the product is dropped below a certain preset level, the float switch will be dropped down towards the tip of the probe (switch is then read as “closed” position). The test also verifies the wiring from the probes to the pump board inside the IO module.
	 Test Pick-up Probe - inside container (full)

	Test Pickup Probe – outside container (empty)
---	---

2.8.3. Submenu #8.3 Diagnostics>Condor Controller>LCD Test

This submenu allows the user to perform diagnostic testing of the Condor Controller and its internal components.

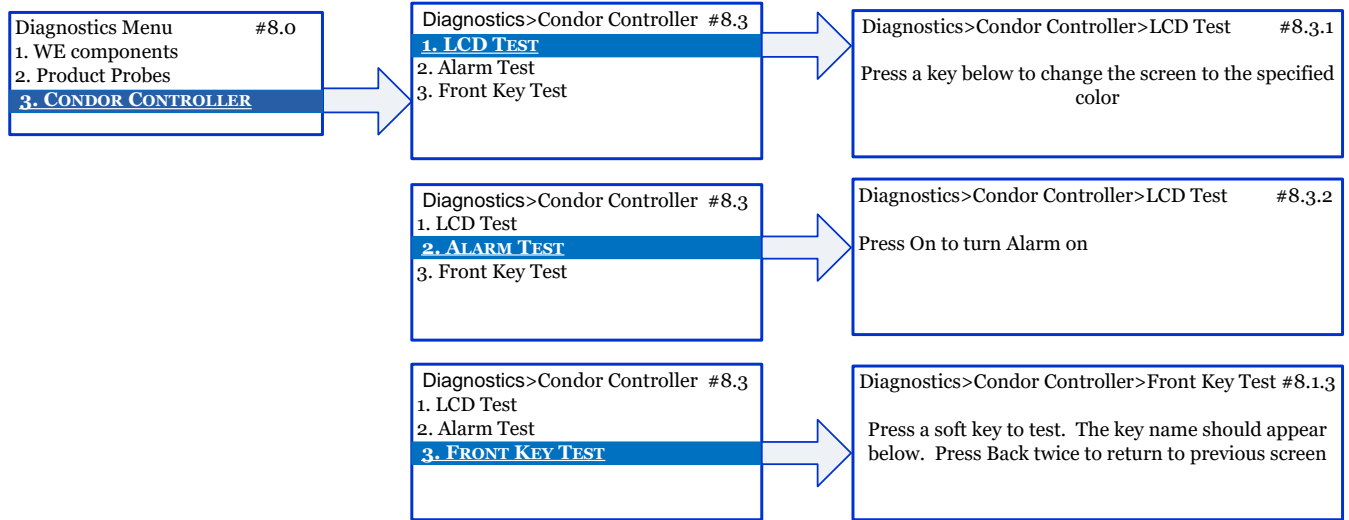

Screen	Description
8.0	Diagnostics Menu
	The Diagnostics Menu consists of 3 sub-menus allowing for functional verification of all modules connected to the Condor controller, and all discrete components controlled by the I/O board (water valve, product valves, machine valves, etc).
<ENTER>	Proceed with Condor Controller diagnostics
8.3	Condor Controller Diagnostics
	LCD – choose a background color to test the Condor display
	Alarm – Turn on/off audible alarm
8.3.1	Front Key – when a soft key is pressed, the name of the key will be displayed on the Controller
	<ENTER> Proceed with the highlighted test
8.3.1	Choose a soft key to test the Condor Display (Red, Blue, Green)
8.3.2	Use soft keys to turn audible alarm on or off
8.3.3	Press various softkeys and observe display on Condor Controller

3.0 Start-Up and Operation

The following procedures take you through a step-by-step routine to verify the AQUANOMIC EU dispenser has been installed and functions properly. Before proceeding with this section, the following items should be completed:

- ✓ Wash formulae programmed into Condor Controller.
- ✓ Washer chemical request signals are programmed to match steps in Condor Controller.
- ✓ Mount Condor Controller and Pump Cabinet.
- ✓ Mount MSI and Formula Select modules.
 - Assign each a unique address (#1-3).
 - Daisy chain all modules together.
- ✓ Make tubing and electrical connections to and from Pump Cabinet.
- ✓ Connect Pump Cabinet to appropriate power source.

NOTICE

Upon dispenser start-up, the Condor main screen will read “Please wait...” while the system is connecting and syncing to all daisy chained modules. Do NOT press any buttons while this message is displayed on-screen.

3.1 Product/Wash Signal Check

NOTICE

This check is done without products. Dispensing products will be done after the hydraulics and washer valve operation has been verified.

1. Select a formula and run the laundry machine through a complete cycle.
2. The pump should run as programmed (pre flush and post flush). The screen will display when a dispense is running. Refer to section 1.2 Customer Screens.
3. If dispenser does not run as programmed, check the signal LEDs on the Machine Interface. If they do not light at the time the washer should be calling for product, then re-check the trigger wiring.

3.2 Hydraulics Check

1. Enter the TM screens on the Condor Controller by holding center key for 5 seconds followed by the password. (Up, Down, Left, Right, and enter (center square)).
2. Use down arrow key until “Diagnostics” is highlighted. Press enter.
3. Select “WE Components” and Washer number.
4. Select “Main Water Flush” and perform a 30 second main water flush to each washing machine to ensure proper valve wiring and operation. During each diagnostic flush:
 - Check for leaks.
 - Check water pressure at the regulator gauge – adjust if needed.
5. Write down date of installation on Maintenance Service Label on inside of front cover.

3.3 Product Dispense Check

WARNING

Wear proper PPE when first starting up the system with products.

NOTICE

If any problems are encountered, consult **Section 4.0 Troubleshooting**

1. Place products in dispenser.
2. Enter "Programming Mode" on the Condor by holding center key for 5 seconds followed by the password.
3. Scroll down and select "Diagnostic."
4. Select "WE Components".
5. Select desired product to be dispensed. The product will be dispensed for 60 seconds followed by a 30 second post-flush.
6. Select second and third product to be dispensed and repeat dispense cycle.
7. At the laundry machine, a titration could be completed to ensure the correct washing machine received the correct product.

3.4 Customer Operation

The customer needs to be shown how to understand and operate the following items as described in section 7.0.



1. Use of main ON/OFF switch.
2. Use of Formula Select, if used.
3. Use of Condor Controller features and alarms.
4. How to access Load Counters, if needed.
5. How to re-fill solid capsules and drop-in bleach product.

4.0 Troubleshooting

⚠ WARNING
Wear proper PPE when troubleshooting the system.

Category	Symptom	Cause	Action
4.1 Condor/Formula Select/MSI	4.1.1 No display on main controller. FS screens are dark (no power)	Power up cycle is locked up	Reset circuit breaker by cycling Main ON /OFF power switch.
	4.1.2 No Display on some FS screens (with backlight on)	Conflicted communication address setting (each must be set with a unique address)	Verify address setting at each FS module.
	4.1.3 Controller displays minimal information with no access to programming mode	Controller database is corrupted or not properly synchronized	Reset system AC power.
	4.1.4 No display on main Controller or remote FS module is backlit and blank	No AC Power Source	Verify AC power source is connected.
		I/O Module circuit breaker tripped	Reset circuit breaker by cycling Main ON /OFF power switch.
		Poor communication cable connection	Reconnect or replace cable. (Make sure Power is OFF.
		Malfunctioning Fuse FSHLDR1	Check DC green power lights on I/O Circuit board at DS1 (upper right corner). If no green light, check fuse at F1 (upper right corner). If bad, replace fuse.
		Malfunctioning DC power supply	Check DC green power lights on I/O Circuit board at DS1 (upper right corner). If no green light, check fuse at F1 (upper right corner). If fuse is good, replace DC power supply.
	4.1.5 Controller only shows one washer icon (when multiple washers are desired)	Malfunctioning Controller	Replace controller.
		Incorrect Number of Washers setting	Adjust setting under the Quick Setup Menu.
	4.1.6 Formulae are not being counted	Formula Programming Error	Check formula steps and correct programming error.
		Formula Not Finished Error	Check to see if washer has been forwarded, signals have been skipped, or if there are any empty product capsules. Train customers/review wash procedure.
MSI Communication Error		Check communication cable connections to MSI module. If connection is good, fix/replace the MSI module. Don't forget to set the new MSI module at the correct address.	

4.2 Pump Cabinet- plumbing	4.2.1 Water from overflow tube	Pressure regulator set too high	Reduce the pressure.
		Blocked check valve	Replace with new.
		If pump is not running, determine if pump circuit is faulty	Turn Pump Cabinet power OFF and check all of the pump circuit connections. Use the wiring diagrams in section 5.0.
			Turn Pump Cabinet power ON. In the Diagnostic menu, turn on pump. If pump does not turn on, replace the contactor, cord, or pump.
		If pump is running	Check if solution is flowing to machine. If not, refer to Symptom 4.2.2.
		Turn Pump Cabinet power OFF	If water continues to flow, repair or replace the main solenoid valve.
		Delivery tubes have too much back pressure	Shorten tubing lengths and reduce height of tubing overhead.
		Pinched delivery tube	Repair as needed.
		Injection point in laundry machine is too small	Drill out to maximum diameter to prevent any back pressure.
		4.2.2 Pump runs but will not move any fluid to the washing machine	Check valve obstructed
Machine Washer valve is not opening	Refer to Symptom 4.4.		
Pinched delivery tube	Repair as needed.		
4.3 Pump Cabinet- electrical	4.3.1 When turning on power switch, Condor Controller screen does not light up	No power supply	Check power supply power, cord, or transformers, along with power supply inside I/O board enclosure.
		Power switch failure	Turn power switch ON and OFF a few times to see if it ever comes on. If not, replace power switch.
4.4 Pump Cabinet Washer Valve issues	Washer #1 = Brown wires, Washer #2 = Gray wires, Washer #3 = Pink wires *	No Water Supply	Verify water supply is ON.
		Fluid coming out of wrong washer solenoid valve	Verify valve's wire colors.
		Fluid not coming out correct valve	Measure 24VAC coming out of correct color of wires.

Misc.	4.5 Fouled Product Spray Screens	Low water pressure at the spraying nozzle in sump	Increase pressure at regulator.
		Temperature too hot	Check water temperature. If too hot, add tempering valve.
Misc.	4.6 Product consumption too high	Check product solenoid valves for proper operation	If the valve does not immediately close when power is removed, the diaphragm is weak and should be replaced.
		Check wires and conductivity cell	Ensure cells and wire connections are pushed in all the way. Might also need to clean/wipe off cells.
Misc	4.7 No product feeds	No laundry machine signals	Check laundry machine output voltage and wiring.
		Controller Failure	Verify a valid signal is present at MSI by watching LEDs light during washer operation. If the LEDs light , highlight the desired washer and check the MSI to controller communication by selecting  >  on the controller. If no signal is displayed on the Condor, replace controller.
		MSI Failure	Verify a valid signal is present at the MSI by watching the LEDs light during washer operation. If the LEDs do NOT light , verify presence of a valid supply signal with a voltmeter at the MSI module. If supply signals are present, replace MSI.
Misc	4.8 Not selecting correct formula	Check Micro-Mode and Manual Mode settings	Select one or the other.
		Failed RS-485 cable	Replace cable.

5.0 Wiring Diagrams

5.1 MSI Wiring Diagram

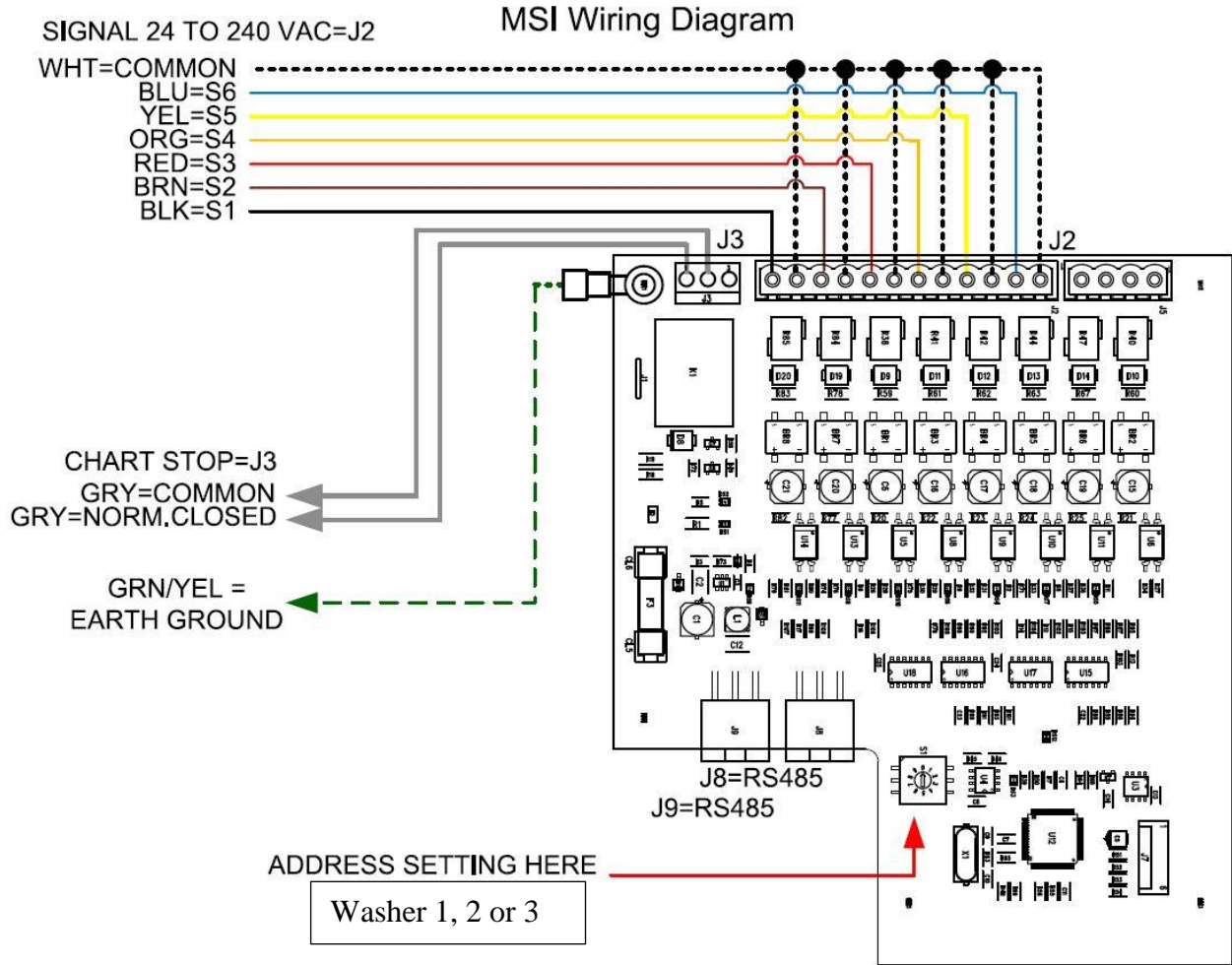

5.2 IO Board Wiring

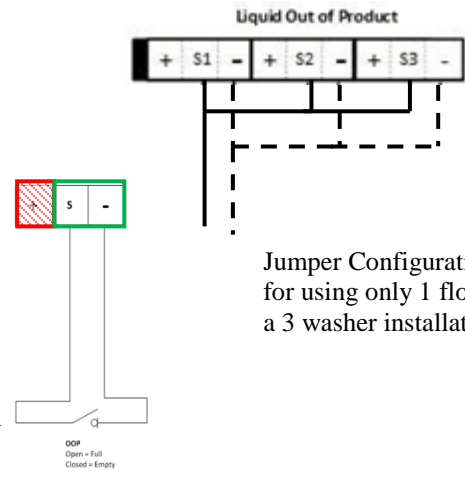
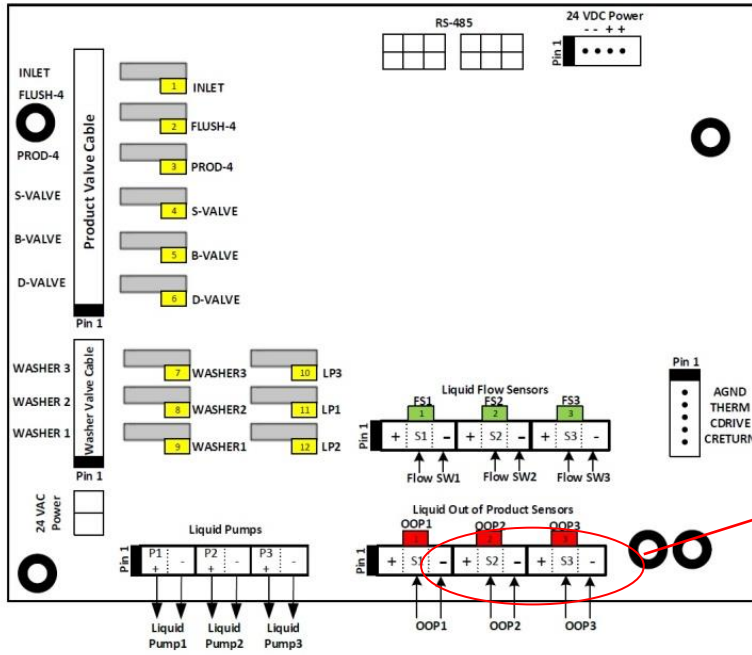

Jumper Configuration
for using only 1 float for
a 3 washer installation.

5.3 Pump Cabinet Wiring

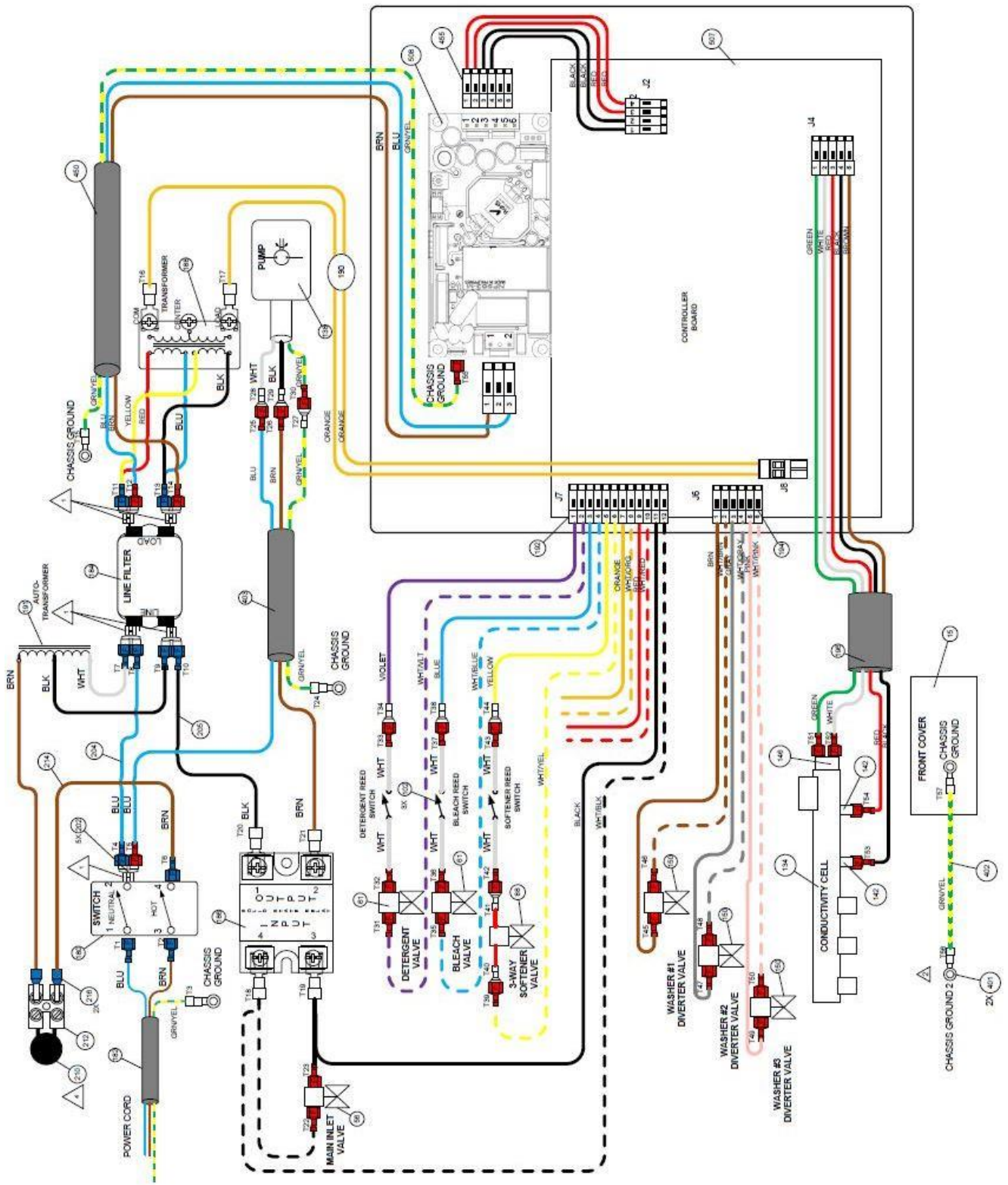

6.0 Maintaining & Servicing the System

⚠ WARNING

Main dispenser power must be disconnected prior to maintaining or servicing the unit. Power switch must be set to “off” and power cord must be removed from wall power socket.

⚠ WARNING

Always wear appropriate Personal Protective Equipment (PPE), including eye/face protection, gloves, and aprons, when replacing chemicals or coming in contact with any liquid in the system.

NOTICE

Do not plug or unplug RS-485 cables when power is applied to the system. Do not apply power to the system until all modules are properly addressed and all RS-485 cables and plugs (dongles) are properly connected to the modules.

6.1 Pump and Outlet Manifold Replacement Procedures

1. Power down Aquanomic EU by unplugging power cord on Pump Cabinet.
2. Remove front cover using key and keylock underneath the Pump Cabinet, front and center. Cover can be stored between dispenser and the wall, resting on the wall mounting bracket to relieve strain of the grounding wire.
3. Disconnect washer valve’s discharge tubing from check valves.

⚠ WARNING

Post-Flush water will drain out of the tubing. When disconnecting black sump drain hose elbow fitting from pump and disconnecting the outlet manifold from pump, post-Flush water will drain out.

4. Disconnect black sump drain hose elbow fitting from inlet into pump.
5. Disconnect all (10) wires that go to the washer’s valves, conductivity sensors, and thermistor.
6. Remove (2) wingnuts located underneath the Pump Cabinet.
7. Lift up on Pump assembly and pull forward a few inches.
8. Reach behind the pump to access the cable connections.
9. Pull connections apart.
10. Finish pulling out pump assembly and bring over to table.
11. Carefully take pump assembly apart and repair parts as needed.

6.2 Electrical components behind I/O Board enclosure.

1. Power down Aquanomic EU by unplugging power cord on Pump Cabinet.
2. Remove front cover using key and keylock underneath the Pump Cabinet, front and center.
3. Looking underneath the Pump Cabinet, there are (2) wingnuts on the right side. Remove both wingnuts.
4. Above the I/O Board enclosure, there are (2) screws. Loosen these a few turns.
5. Slide enclosure to the left a small distance to dis-engage the screws. Now the enclosure can be rotated slightly to the left- being careful with the 3 bundles of wires coming out the side of the enclosure.
6. You are now looking inside the compartment. You may now remove the metal shield by pulling it up slightly and then taking it out.

⚠ WARNING

Inside the stainless steel compartment, there is high voltage components. Please be careful when replacing parts.

7.0 Operating Instructions for Account Personnel

Customer Daily Checklist

At the beginning of each day, it is highly recommended that account personnel verify proper system operation by performing the following checks:

- ✓ Check to ensure Condor Controller screen is on.
- ✓ Check Condor Controller screen for active alarms; clear alarms if necessary.
- ✓ Check system for any signs of chemical leaks/dripping.
- ✓ Check product level in product containers – if using optional 4th liquid product.

If any issues are encountered with these checks, contact your Ecolab Sales Representative.

7.1 Introduction to the AQUANOMIC EU

The AQUANOMIC EU is a 3-solid product laundry chemical dispensing system. The system provides for flexible installation to service up to (3) laundry washing machines.

System Features:

- Service up to (3) washing machines located up to 50 ft away from Pump Cabinet.
- Utilizes safe, accurate conductivity sensors to measure amount of product being dispensed.
- Capacity to add a 4th solid or a liquid product.
- Capable of programming/selecting 15 formulae per washer
- Automatic data recording
- Queue tracking
- Selectable operating logic allows unit to be used with all washer styles
- Multiple user language options with region-specific weights and measures
- Icon-based display
- Visual and audible system alarm

The AQUANOMIC EU system is operated by the Condor Controller. The controller main idle screen is diagrammed below. The Condor can be used to select a formula, view load counts, and view system errors. A more detailed explanation of the Condor's functionality is explained in the following section.

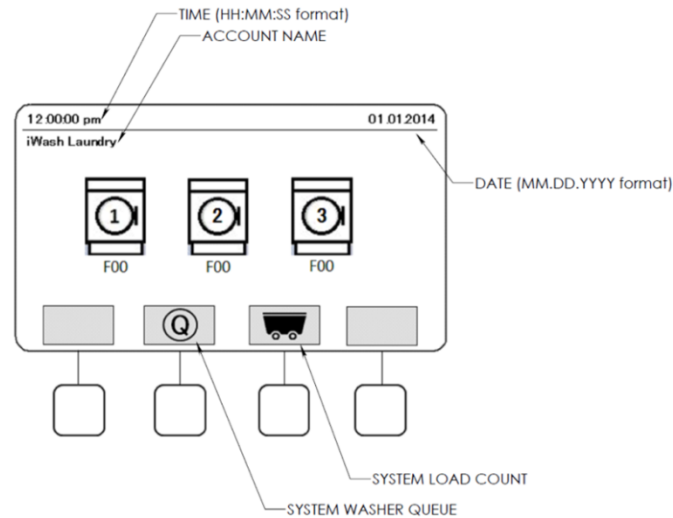

The pump will dispense chemistry to 1 of the 3 washing machines. There is a 30 second pre- and post-flush after each product is dispensed.

The Smart Queue Logic built into the controller allows for efficient and timely servicing of multiple machines. As chemical request signals are received from the washers, the requests are logged into the system's dosing queue. The system identifies the chemical request signals coming in and assigns them a priority. Chemical request signals with the highest priority will be dosed first.

7.2 Selecting a Wash Formula

There are three ways a wash formula can be selected on the AQUANOMIC EU system.

1. On the Formula Select module
2. On the Condor Controller
3. Automatic selection by washer (MicroMode)

Selecting a Wash Formula: Formula Select Module

The Formula Select is an optional module that is intended to be installed on the front of each machine. If no formula select modules are present, refer to the following two sections: Condor, MicroMode.

NOTICE

A formula must be selected on the washing machine as well as on the Formula Select module. If the system is set up for MicroMode, the formula will only need to be selected on the washing machine.

Use the Up/Down arrow keys to scroll through the formula list.

Press the Center <Enter> key to select a formula.

If the <Enter> key is not pressed and a formula is highlighted for 10 seconds, the formula will be auto-selected.

Press BOTH Up and Down arrow keys to cancel a formula.

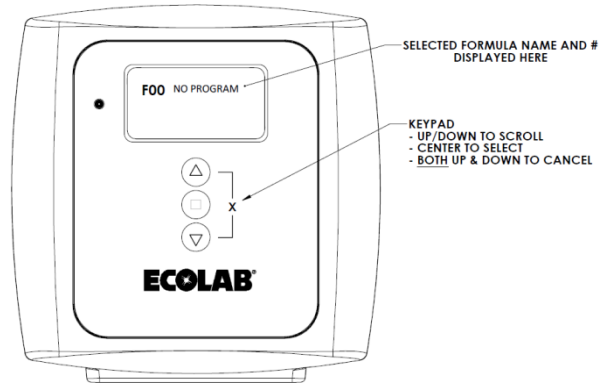

If no formula is selected, the Formula Select will display “F00 No Program”. Once a formula has been selected, the formula name and number will be displayed on the Formula Select display screen.

Once a formula has been selected on the Formula Select module, the Condor Controller should reflect the selection:

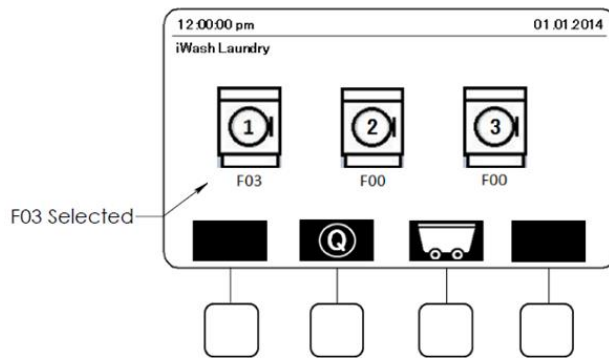

NOTICE

Formula must be selected on the washer AND the Formula Select module.

Selecting a Wash Formula: Condor Controller

If no Formula Select modules are present and the washer is not in MicroMode, the wash formulae must be selected using the Condor Controller.

NOTICE

A formula must be selected on the washing machine as well as on the Condor Controller. If the system is set up for MicroMode, the formula will only need to be selected on the washing machine.

A formula can be selected from the main idle screen on the Condor Controller.

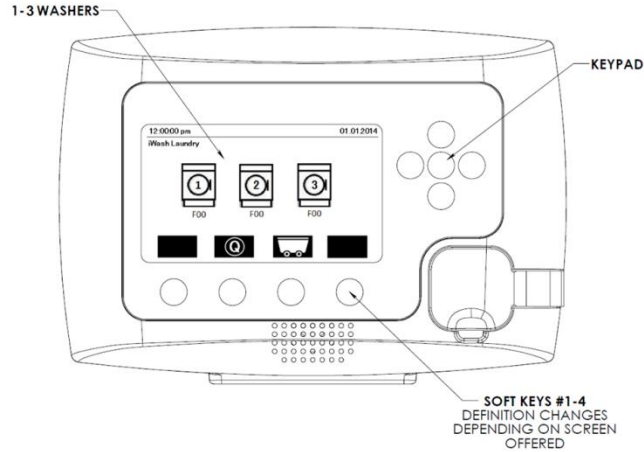

1. Use the Left/Right arrow keys on the keypad to scroll between washers. Doing so, will highlight the washer icons and update the soft-key options.

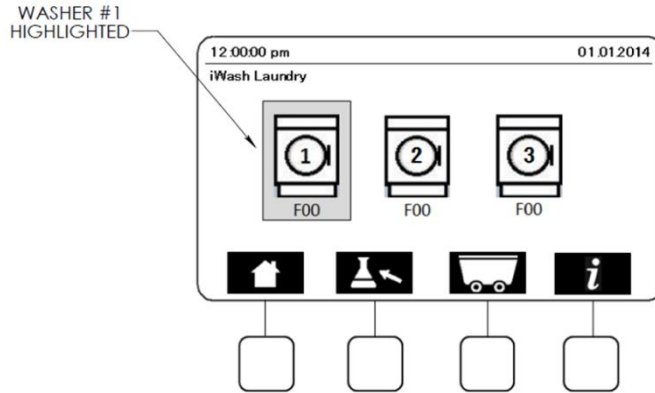

2. With the desired washer highlighted, press  to Select a Formula. This will pull up a list of the pre-programmed formulae offered.

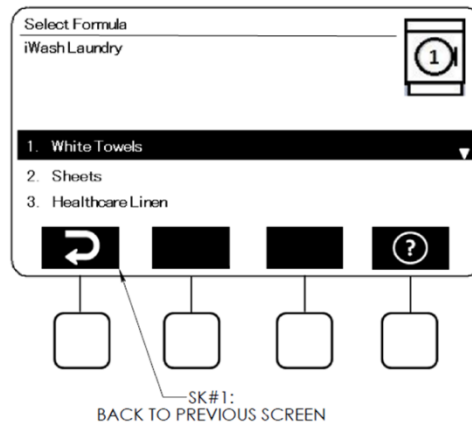

3. Use the Up/Down arrow keys to highlight a formula. Press center <Enter> to select.
4. Once a formula has been selected, the controller will momentarily display the screen below while it processes the request.

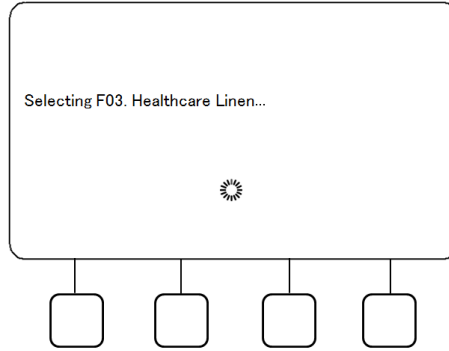

- If the command fails to process, the Condor will notify the user of the failure. Try repeating the command. If still unsuccessful, call Ecolab Territory Manager for troubleshooting.

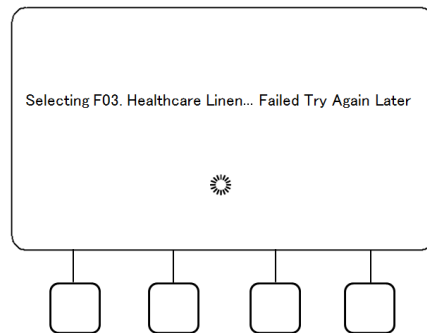

- If the command is successfully processed, the main idle screen on the Condor will update to show the formula as active underneath the machine it was selected for.

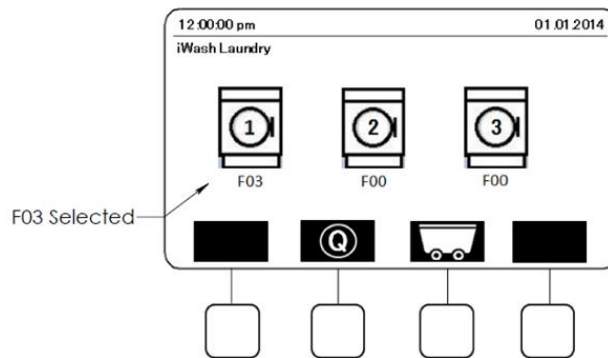

- The Formula Select module (if installed) will also update to reflect the selection on the Condor:

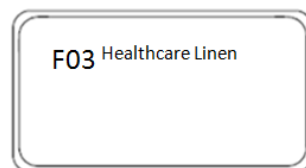

- To modify or cancel the formula after it has been selected, highlight the washer using the Left/Right arrow keys

and press the Modify Formula  soft-key.

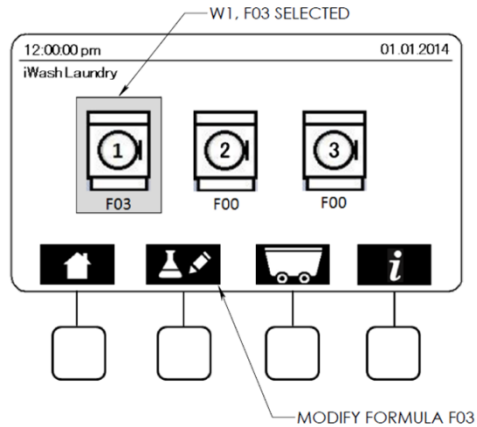

9. Use the Up/Down arrow keys to highlight a selection. From here, the formula can be cancelled.

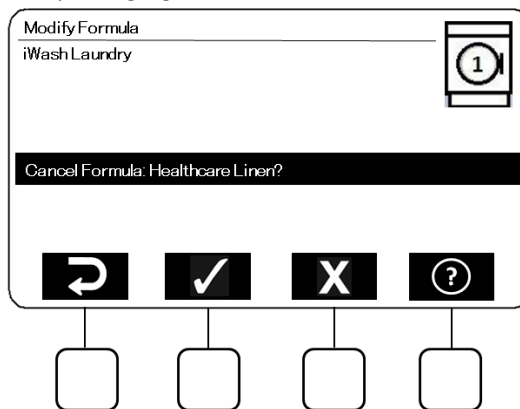

10. If the formula is cancelled, the selected formula F03 for this washer will be reset to F00 and all doses will be removed from the system queue. The main idle screen on the Condor controller and the Formula Select will display F00 No Program. Note: if this is done during the middle of a formula, it will result in a Formula not Finished Error.

Selecting a Wash Formula: MicroMode

If the washing machines are set up in MicroMode, manual formula selection is not necessary. The washing machine will send the timed pre-programmed signals directly to the dispenser, automatically selecting the correct wash formula.

If Formula Select modules are installed, the display will show the washer in “Automatic Mode” on the top line.

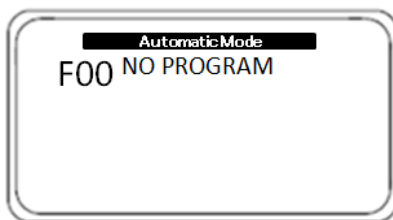



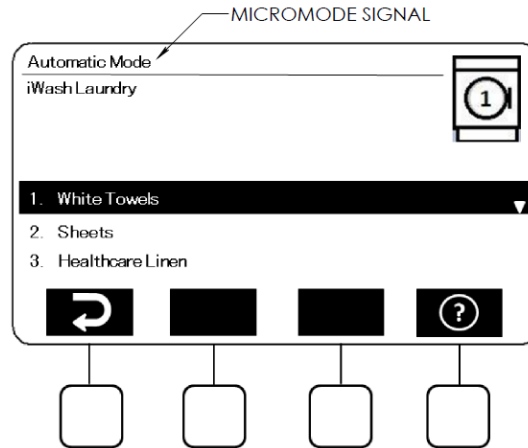







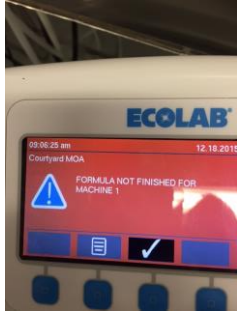





The formula selection menu on the Condor can be accessed as described in the previous section. However, a formula cannot be selected using the manual keypad. The Center <Enter> key is now disabled.

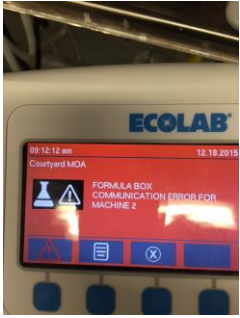

7.3 System Alarms

Alarms screens are typically displayed on the Condor with a red background. The images below are displayed on the Formula Select and Condor controller when the system detects an operating parameter outside of its designed specifications.

Error Displayed	Error Definition	To Clear Error on...		
		Formula Select	Condor Controller	
	<p>Formula Not Finished (incomplete formula)</p> <p>Occurs when the Condor does not receive all signals programmed into a wash formula or a product is not fully delivered (out of product, etc.)</p> <p>Causes:</p> <ul style="list-style-type: none"> - Washer has been forwarded (chemical request signals skipped) - Chemical request signals not properly programmed on washer - Operator opens washer door and leaves for day/shift/break (washer times out) - Solid or liquid product is empty (or nearly empty) - System is plugged downstream of sump screen - Wash step has been deleted from queue 	<p>Press Any Key</p>		
	<p>MSI Communication Error</p> <p>Occurs when communication is lost to an MSI module.</p> <p>Causes:</p> <ul style="list-style-type: none"> - Poor/broken communication cable connection - Faulty MSI Module - MSI Module(s) are improperly addressed <p>Effect: Service is lost to any washer in the daisy chain after the point of failure. System operation will be adversely affected.</p>	<p>Press Any Key</p>		
<p>Contact Ecolab Service Personnel</p>				

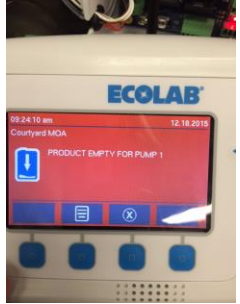
	<p align="center">Formula Select Communication Error</p> <p>Occurs when communication is lost to a Formula Select module.</p> <p>Causes:</p> <ul style="list-style-type: none"> - Poor/broken communication cable connection - Faulty Formula Select Module - Formula Select Module(s) are improperly addressed - Optional Formula Select configuration not properly set up in System Settings <p>Effect: Service is lost to any washer in the daisy chain after the point of failure. System operation will be adversely affected.</p> <p align="center">Contact Ecolab Service Personnel</p>	<p align="center">Press Any Key</p>		
	<p align="center">IO Board Communication Error</p> <p>Occurs when communication is lost to the IO board.</p> <p>Causes:</p> <ul style="list-style-type: none"> - Poor/broken communication cable connection - Faulty IO board <p>Effect: System will not operate.</p> <p align="center">Contact Ecolab Service Personnel</p>	<p align="center">NA</p>	<p align="center">Alarm can't be cleared. Service required.</p>	
	<p align="center">Product Empty for Pocket X (solid product)</p> <p>Occurs when conductivity reading does not reach expected level.</p> <p>Causes:</p> <ul style="list-style-type: none"> - Empty product container - System plug at or downstream of sump screen <p>Effects:</p> <ul style="list-style-type: none"> - Product X will not dose - Formula Not Finished alarm will occur at end of wash formula 	<p align="center">Press Any Key</p>		
	<p align="center">Product Empty for Pump X (liquid product)</p> <p>Occurs when liquid product level sensor triggers out of product.</p> <p>Causes:</p> <ul style="list-style-type: none"> - Liquid product container is empty. - Liquid product level sensor is faulty or disconnected. <p>Effects:</p> <ul style="list-style-type: none"> - Liquid product pump for triggered product will not pump. - Formula Not Finished alarm will occur at end of wash formula 	<p align="center">Press Any Key</p>		

7.4 Viewing Load Counts

The production load counts of each formula on each washer are available through AQUANOMIC EU recording. To access the data, follow the instructions below.

To view/access total system Load Counts, press Soft Key #3  Load Counts from the Condor idle screen.

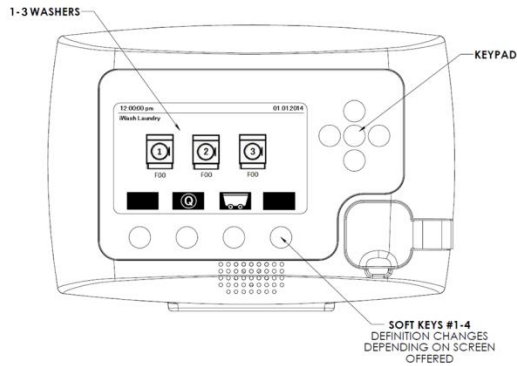



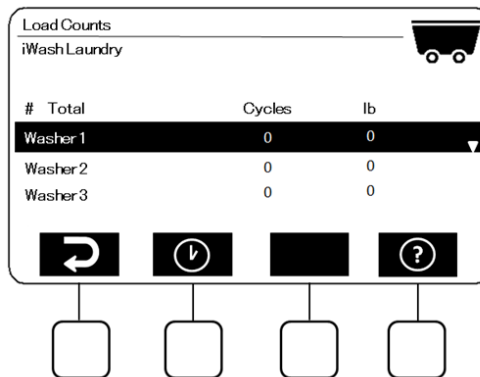





The load counts for all washers will be displayed. Use the Up/Down arrow keys to browse load counts for each washer. Press Soft Key #1 <Back> to return to the Condor main idle screen.



To view/access total system load counts specific to each washer, highlight the desired washer before selecting SK#3  load counts. The formula list for the washer will be displayed. Use the Up/Down arrow keys to browse load counts for all formulae.

Load Counts			
iWash Laundry			
#	Total	Cycles	lb
1.	White Towels	0	0
2.	Sheets	0	0
3.	Healthcare Linen	0	0
4.	Color Bed Linen	0	0

7.5 Replacing Empty Products

After replacing an empty product capsule or block, the next dispense should clear the alarm.

For details on proper product replacement procedure, consult Ecolab service personnel.

WARNING

Always wear appropriate Personal Protective Equipment (PPE), including eye/face protection, gloves, and aprons when replacing chemicals.

1. Ensure new product capsule is the same product container that was emptied.

WARNING

The mixing of incompatible laundry chemicals can result in a dangerous chemical reaction with the potential to cause severe injury and property damage. Empty product containers **MUST ONLY** be replaced with new containers of the exact same product.

8.0 Replacement Parts

PHOTO	EE-DESCRIPTION EBS-DESCRIPTION	US DISPEN- SER	EU DISPEN- SER	EE-ITEM- NO.	EBS-CODE
	VLV SLND 1/4FNPT 24V ENCL A AQN SOLID SOLENOID VALVE 1/4FNPT 24 V	X	X	85260545	10034212
	NOZ SPY .6 67DEG KYN AQN SOLID NOZ SPY.6 67DEG	X	X	85312502	10034213
	AQN Nozzle Kit AQN Solid 3rd Pocket Nozzle Flush Kit	X		92591159	10037231
	TUBE DRN NAV AFLAS AQN SOLID TUBE DRN NAV AFLAS	X	X	92592472	10034214
	AQGTR MANIFOLD SWIVEL ASSY AQN SOLID MANIFOLD SWIVEL ASSY	X	X	92592551	10034215
	PWR SPLY 90/264VAC/24VDC AQN SOLID PWR SPLY 90/264VAC/24VDCV	X	X	83494022	10034216
	PCB AQUANOMIC SOLID WITH FLOW SENSOR (PWA SCLS/AQNMC EU) AQN SOLID PWA IO *NEW	X	X	92592416	10036160
	NAV ELBOW SWIVEL ASSY AQN SOLID NAV ELBOW SWIVEL ASSY	X	X	92592287	10034217

PHOTO	EE-DESCRIPTION EBS-DESCRIPTION	US DISPEN- SER	EU DISPEN- SER	EE-ITEM- NO.	EBS-CODE
	HOSE WASHER 1 X 5/8 RUBBER HOSE WASHER RUBBER 1X5/8	x		P8579990 6	10004948
	THRMS 25DEG 1/4MNPT SST AQN SOLID THRMS 25DEG 1/4MNPT SST	x	x	83491076	10034218
	VLV CHK 1/4MNPTX3/8BARB PVC AQN SOLID VLV CHK 1/4MNPTX3/8BARB PVC	x	x	85244184	10034219
	RGLTR WTR 1/2 W/GA AQN SOLID WATER INLET REGULATOR	x	x	85220077	10034220
	VLV SLND 24VAC G1/2XG3/8 EU AQN SOLID VLV SLND 24VAC G1/2XG3/8EU	x		85264015	10034221
	AQN SOLID VALVE, 3-WAY, BLEACH, 24VAC AQN SOLID VALVE, 3-WAY, BLEACH, 24VAC	x	x	85261758	10034664
	GA PRESS 2DIA 30LB CB ¼ AQN SOLID PRESSURE GAUGE	x	x	85390079	10034222
	CKT BRKR 3A PNL MT DPST AQN SOLID CIRCUIT BREAKER	x	x	83907451	10034223



PHOTO	EE-DESCRIPTION EBS-DESCRIPTION	US DISPEN- SER	EU DISPEN- SER	EE-ITEM- NO.	EBS-CODE
	CABLE RS485 COMMUNICATIONS 14 FT AQN SOLID CABLE RS485 COMMUNICAT. 14 FT	x	x	92592225	10034224
	CABLE RS485 COMMUNICATIONS 25 FT AQN SOLID CABLE RS485 COMMUNICAT. 25 FT	x	x	92592226	10034225
	CABLE COMM RMT INTFC F1Z 50FT	x	x	92592227	10034682
	FERRITE CORE.18DIA W/CASE AQN SOLID / APEX DATA LINK FERRIT CORE	x	x	83490008	10038038
	REED SWITCH 0,5 AMP. NO REED SWITCH .5A NO	x	x	83051136	10020643
	BAR MAGNET Ø 182 X 1 LONG BAR MAGNET Ø 182 X 1 LONG	x	x	83051102	10020642
	TERMINATING PLUG ASSEMBLY, RS485 TERMINATING PLUG ASSEMBLY, RS485	x	x	92000027	10023769
	VLV SLND 1/4FNPT 24V TFL AQN SOLID VLV SLND 1/4FNPT 24V TLF	x	x	85264232	10034226

PHOTO	EE-DESCRIPTION EBS-DESCRIPTION	US DISPEN- SER	EU DISPEN- SER	EE-ITEM- NO.	EBS-CODE
	AQUAGATOR CONTROLLER PKD AQUANOMIC SOLID CONTROLLER	X	X	92591119	10034238
	LCLS FORMULA SELECT MDL PKD AQUANOMIC SOLID FORMULA SELECT	X	X	92592478	10034240
	BRKT MTG L CONDOR CONT MLD AQN SOLID CONDOR/FORMULA SEL. L-BRACKET	X	X	92002132	10034681
	LCLS MACH SIG INTFC MDL PKD AQUANOMIC SOLID MACHINE SIG INTERFACE	X	X	92592483	10034241
	PMP CNTFGL 115V MAG DR PVDF AQN SOLID PMP CNTFGL 115V MAG DR PVDF	X	X	84606284	10034242
	CELL ELCTD SSIII AQN SOLID CONDUCTIVITY SENSOR CELL	X	X	92582196	10034665
	AQN SOLID 120VOLT FILTER AQN SOLID 120VOLT FILTER	X	X	83493023	10034680

PHOTO	EE-DESCRIPTION EBS-DESCRIPTION	US DISPEN- SER	EU DISPEN- SER	EE-ITEM- NO.	EBS-CODE
	AQN SOLID 240VOLT DONUT TRANSFORMER AQN SOLID 240VOLT DONUT TRANSFORMER	x		83904474	10034667
	AQN SOLID 120VOLT TRANSFORMER AQN SOLID 120VOLT TRANSFORMER	x		83907469	10034670
	AQN SOLID PUMP CONTRACTOR AQN SOLID PUMP CONTRACTOR	x	x	83001131	10034671
	AQN SOLID FLUSH NOZZLE, SST AQN SOLID FLUSH NOZZLE, SST	x		85312718	10034666
	Filter Screen PP ; OD 105 mm ; Mesh 2 mm AQN SOLID OXY GRID	x	x	41131502 2	10036163
	not available at EE Siegsdorf AQN SOLID ICL RETRO KIT	x	x	n.a.	10038040
	not available at EE Siegsdorf AQUANOMIC SOLID DISPENSER OXY INSERT	x	x	n.a.	10038044
	Deflector Type nozzle 1/4" MNPT PEEK AQN SOLID FLUSH NOZZLE (PEEK)		x	41740435 0	10050270

PHOTO	EE-DESCRIPTION EBS-DESCRIPTION	US DISPEN- SER	EU DISPEN- SER	EE-ITEM- NO.	EBS-CODE
	FULL CONE PVDF 4 L/MIN AT 2 BAR AQN SOLID FULL CONE SPRAY NOZZLE		x	41740435 1	10050272
	PRECISION-O-RING 2.9 X 1.78 70 EPDM 291 AQN SOLID CONDUCTIVITY PROBE O- RING	x	x	41700100 7	10050273
	UPGRADE KIT AQN 4th product AQUANOMIC SOLID OXY 4TH PRODUCT KIT		x	278009	10050274
	Stecker für FG line Magnetventil AQN Solid selenoid valve plug		x	41770442 1	10051142
	2/2 Wege Magnetventil 3/8" G / NC aqn solid 2way selenoid valve 3/8" G/NC		x	41770442 0	10051143
	NAVIGATOR PRODUCT SPRAY TUBE AQN Solid PRODUCT SPRAY NOZZLE CONNECTOR	x	x	92592640	10051144
	NAVIGATOR/AQN FLUSH SPRAY TUBE AQN SOLID FLUSH SPRAY NOZZLE CONNECTOR	x	x	92592642	10051145

PHOTO	EE-DESCRIPTION EBS-DESCRIPTION	US DISPEN- SER	EU DISPEN- SER	EE-ITEM- NO.	EBS-CODE
	NAVIGATOR / AQN SPRAY TUBE NUT AQN SOLID SPRAY NOZZLE NUT	x	x	92592643	10051146
	SEAL ORNG .737X.103 EPDM AQN SOLID SPRAY NOZZLE O-RING	x	x	87206165	10051147
	Transformer 230V/115V/24VAC AQN SOLID TRANSFORMER		x	41893103 0	10051148
	Back Flow preventer Mini BA095-3/8E /3/4 OPL SYSTEM SEPARATOR BA		x	41550345 0	10050990
	ELB ST 1/4 304SST AQN SOLID water supply elbow	x	x	86073012	10051149

PHOTO	EE-DESCRIPTION EBS-DESCRIPTION	US DISPEN- SER	EU DISPEN- SER	EE-ITEM- NO.	EBS-CODE
	<p>SCR PHMSS+ 6-32X1/4 SST aqn solid pc board screw</p>	<p>x</p>	<p>x</p>	<p>88159058</p>	<p>10051150</p>
	<p>SCR PHTS+ 6BX3/8 SST aqn solid pc board cover screw</p>	<p>x</p>	<p>x</p>	<p>88223623</p>	<p>10051151</p>